

TYLÖ SAUNA EVOLVE PLUS GF

Layouts

| <u>Sauna room</u> | <u>Page</u> |
|-------------------|-------------|
| E 1414 | 2 |
| E 1712 | 8 |
| E 1717 | 14 |
| E 1917 | 20 |
| E 1919 | 26 |
| E 2217 | 32 |
| E 2219 | 38 |
| E 2222 | 44 |
| E 2419 | 50 |
| E 2422 | 57 |
| E 2719 | 64 |

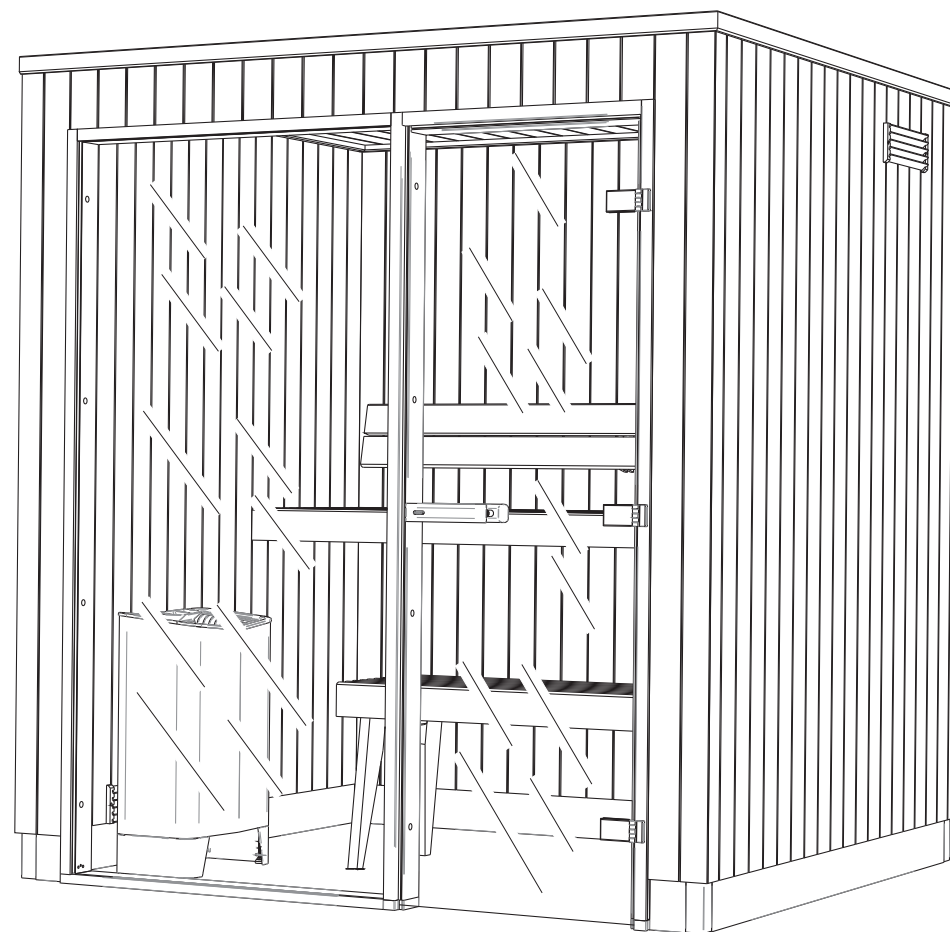

TYLÖ SAUNA E1414 PLUS GF

1202

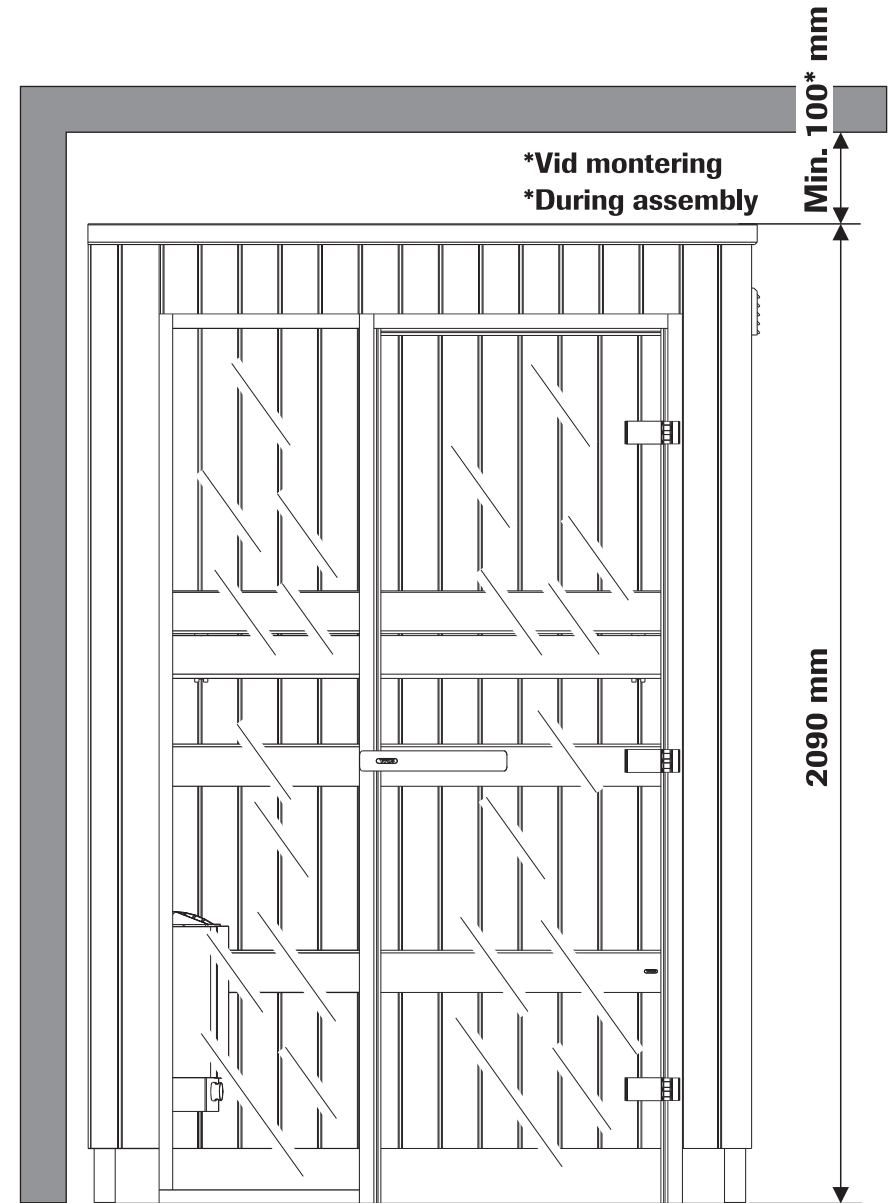
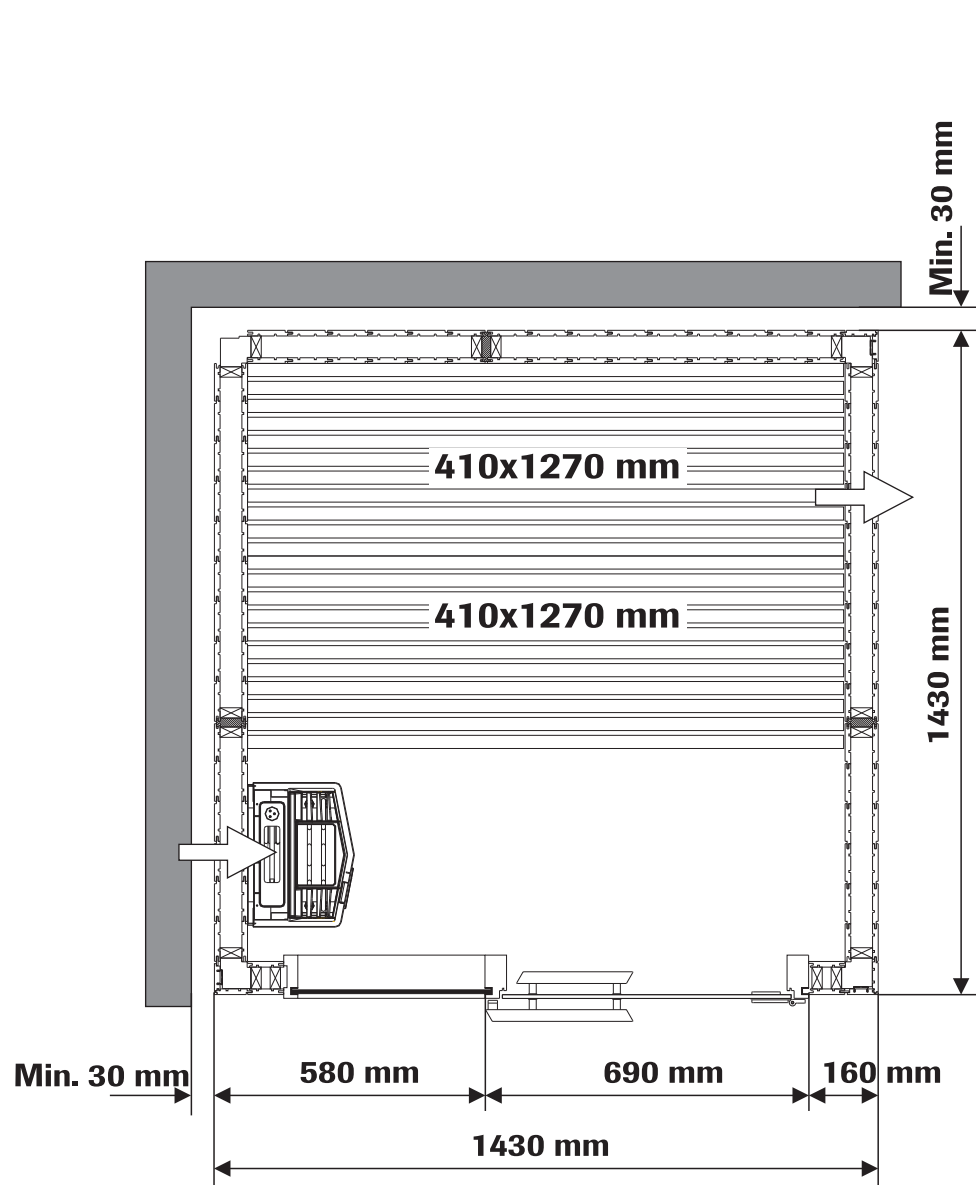

Art.nr 2900 4306

TYLÖ[®]
for the senses

A1

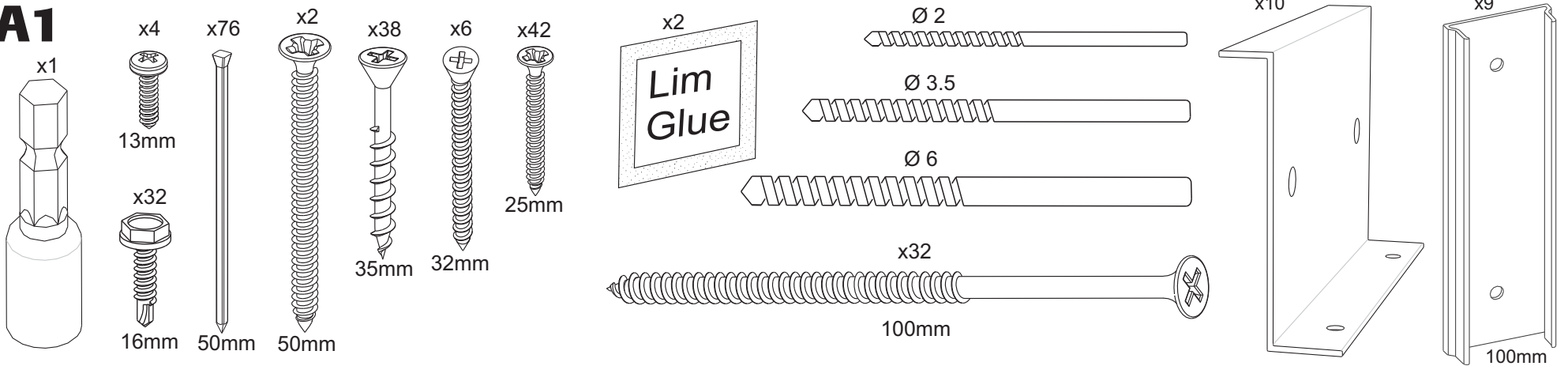

A2

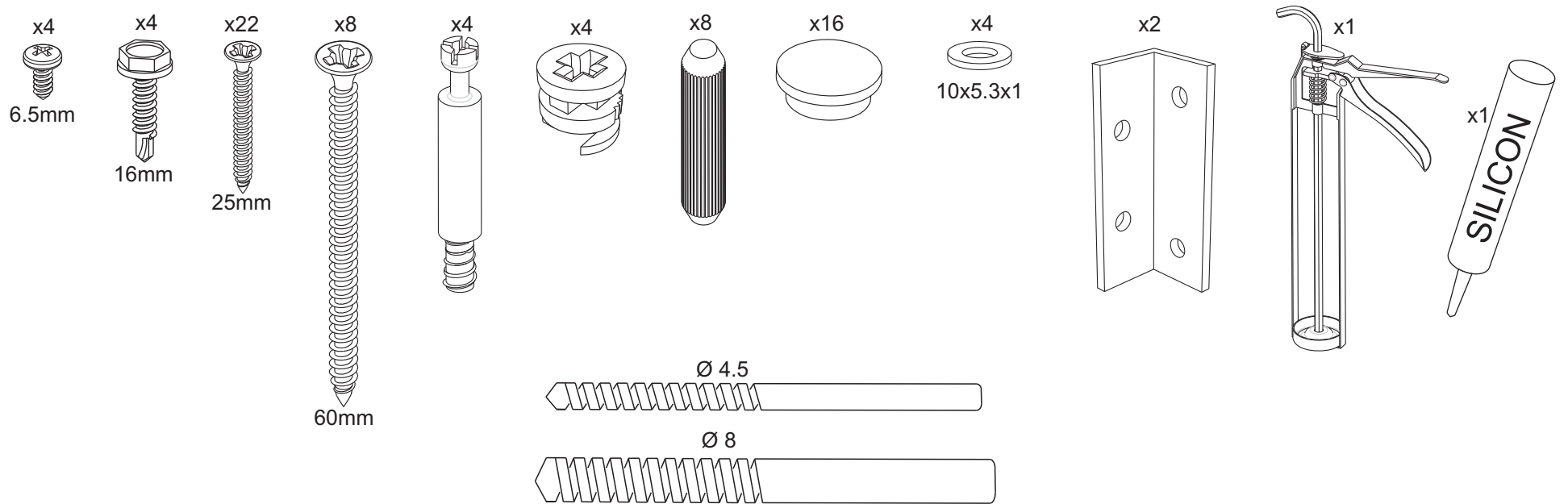

B

x6m

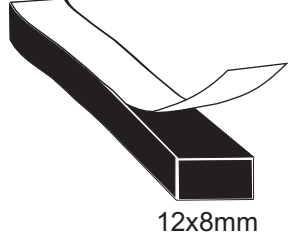

12x8mm

x5m

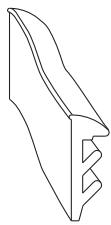

14x5mm

x6

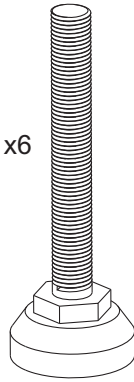
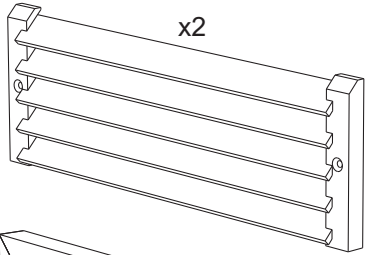
**P1**2x90mm
3x1299mm

x2

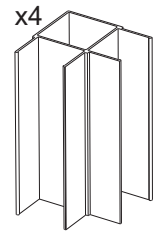

x4

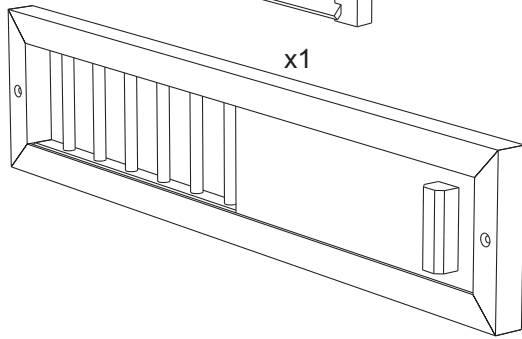

x1

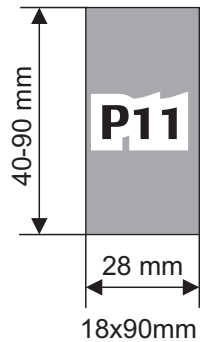
**P11**

28 mm

18x90mm

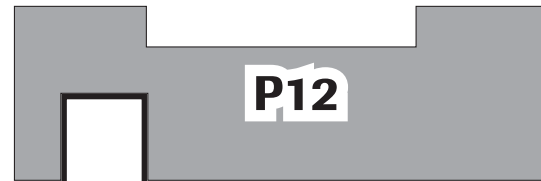
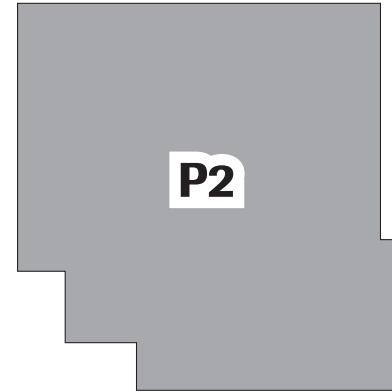
**P12**1x399mm
1x1875mm**P2**

4x1944mm

**P3**3x189mm
1x1265mm
3x1970mm**P4**

3x1970mm

**P5**

3x1970mm

**P6**

2x1750mm

**P7**

2x2000mm

**P8**

4x2000mm

P9

3x1970mm

**P10**

1x1217mm

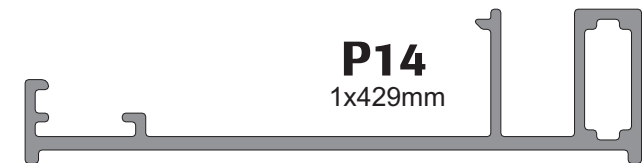
**P13**1x30mm
1x398mm**P14**

1x429mm

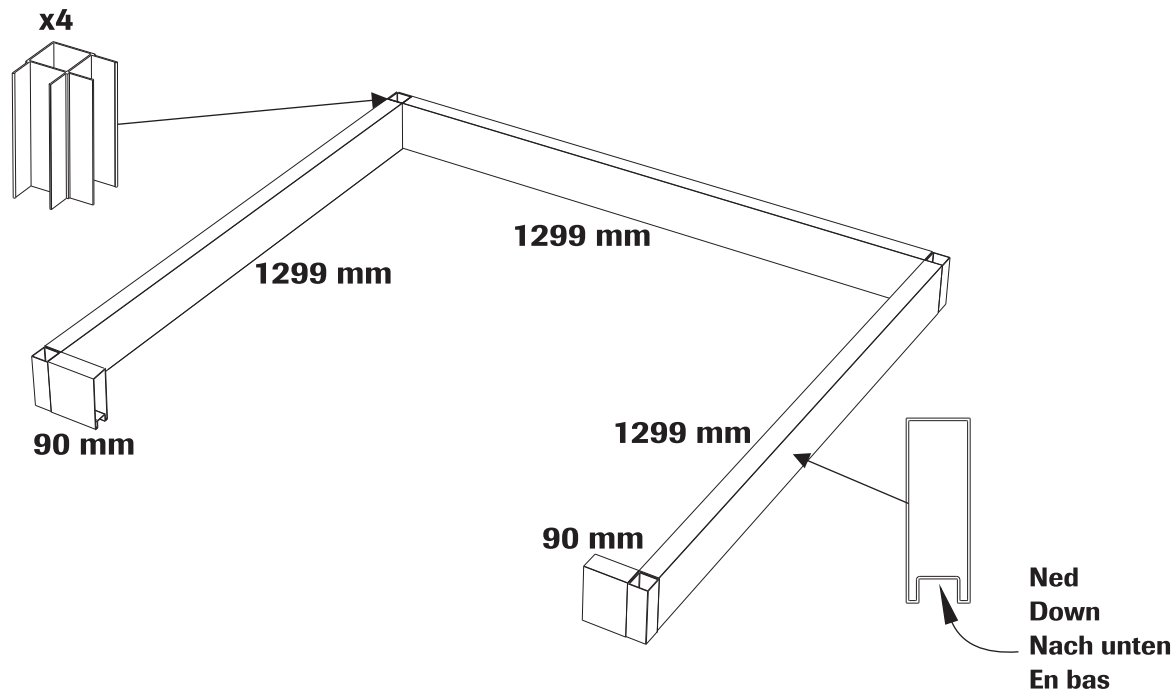
C**D**

Monteringsordning - väggar
Assembly order - walls

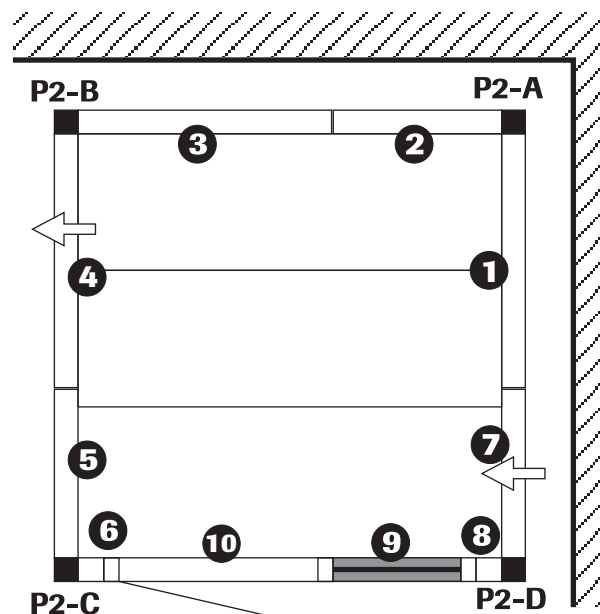
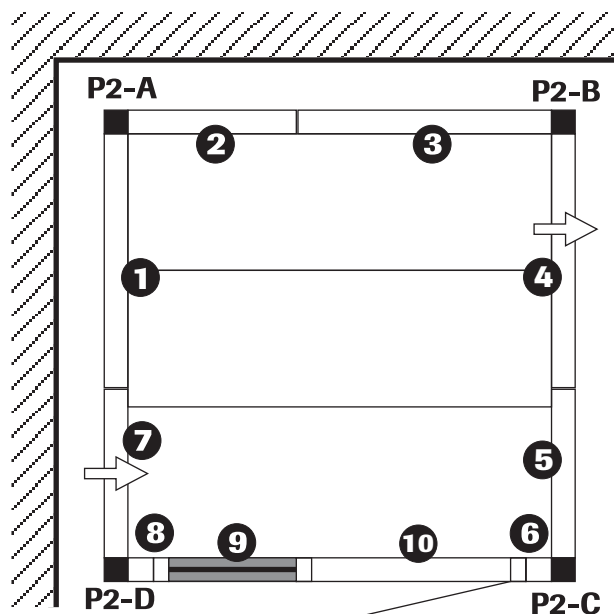

Väggyttermått
Wall outer dimensions

| | |
|--------------------------|--------|
| 2 5 7 | 506 mm |
| 1 3 4 | 762 mm |
| 6 8 | 77 mm |
| 9 (Glas/glass) | 429 mm |
| 10 (Dörr/door) | 690 mm |

E

Placering av skarvprofil.
Montering - se monteringsanvisning av rummet.

Location of the joint profile
Assembly - see installation instructions of the room.

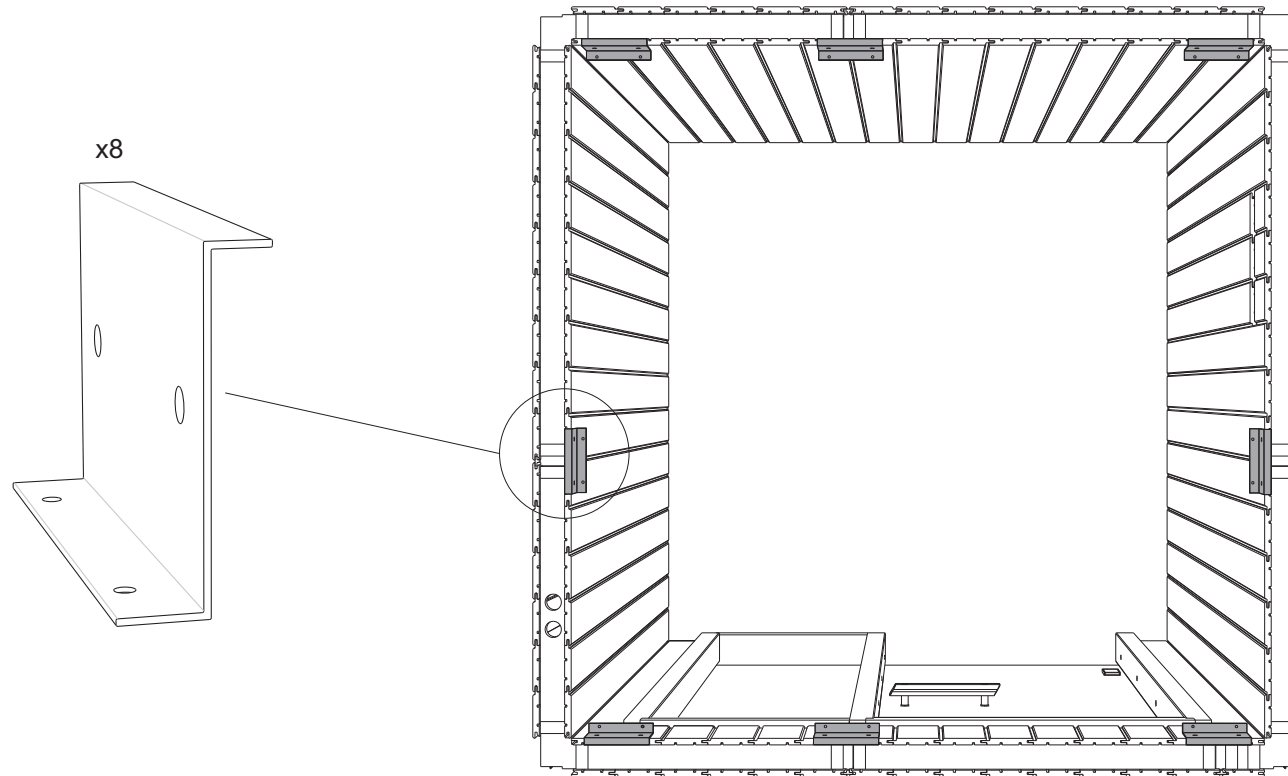

F Layouts 1414 PLUS GF

G = Glass

Standard

Layout 1

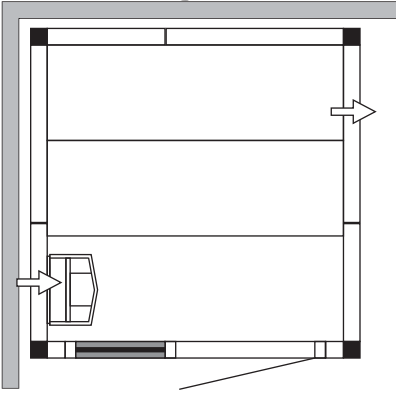

Layout 2

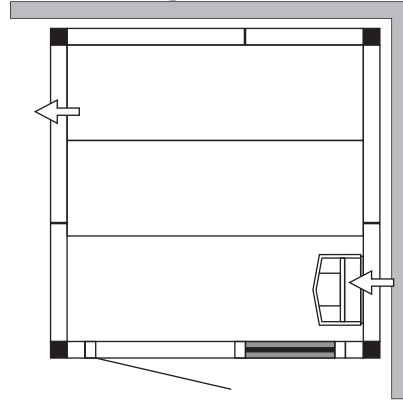

Standard with optional glass section.

Layout 3

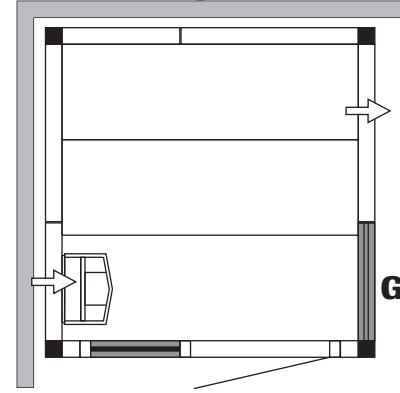

Layout 4

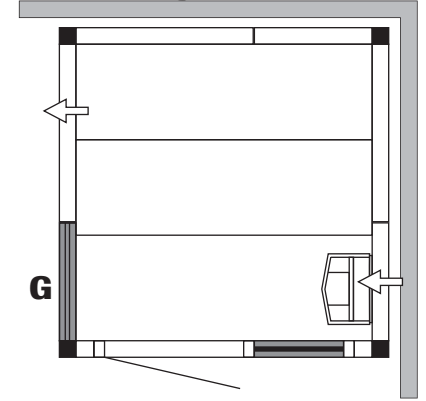

TYLÖ SAUNA E1712 PLUS GF

1202

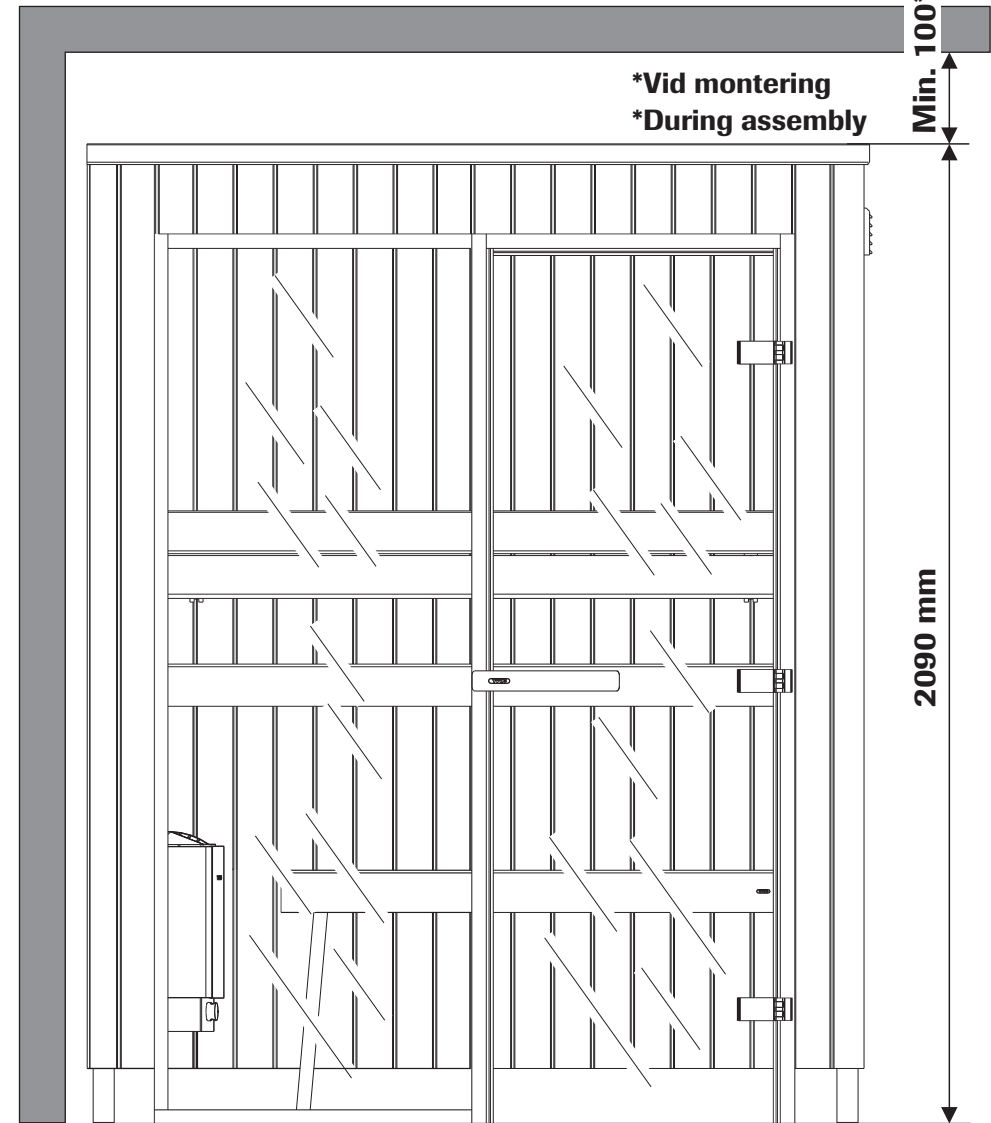
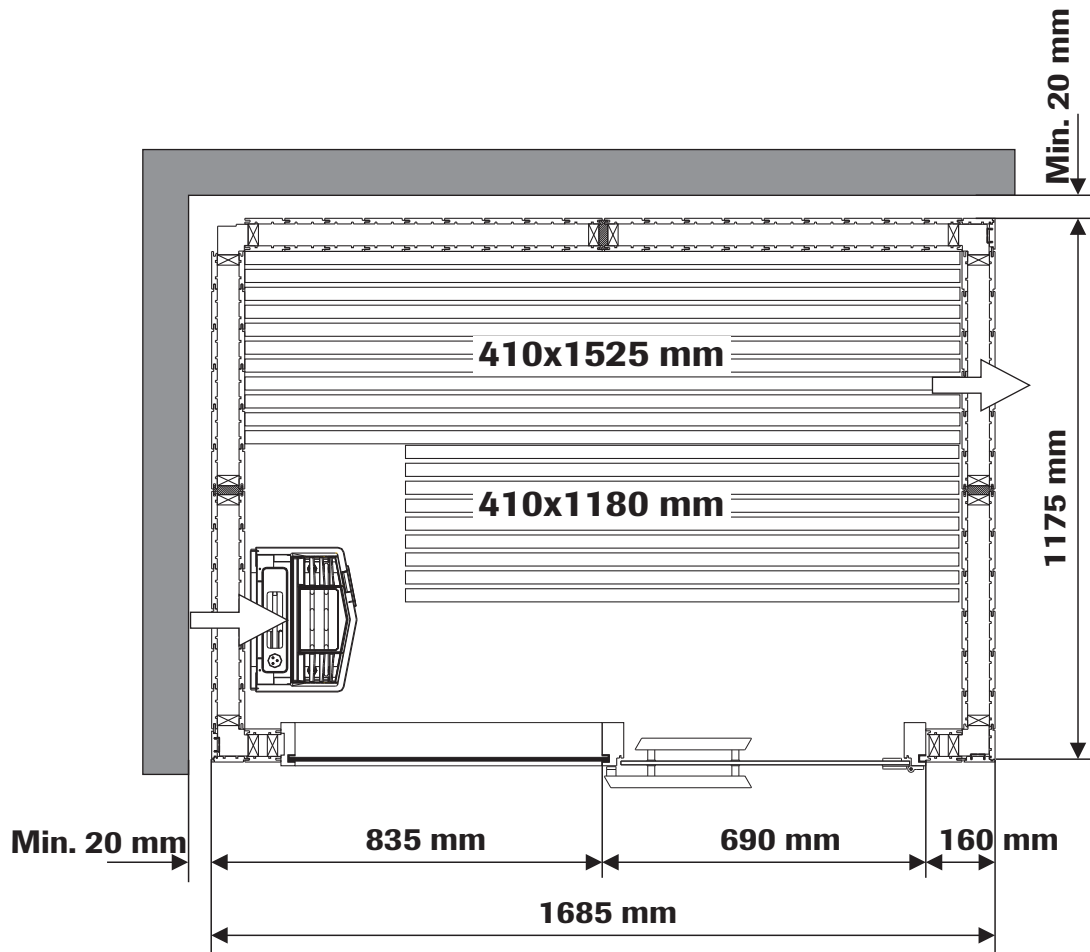

Art.nr 2900 4316

TYLÖ[®]
for the senses

A1

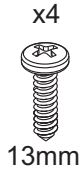
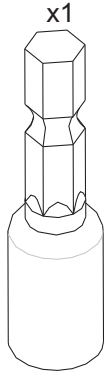

13mm

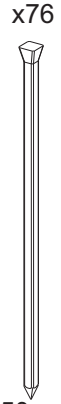

50mm

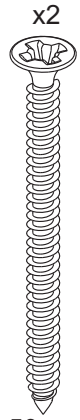

50mm

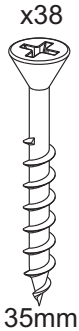

35mm

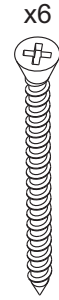

32mm

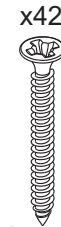

25mm



Lim
Glue



Ø 2



Ø 3.5

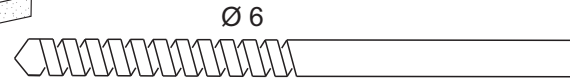

Ø 6

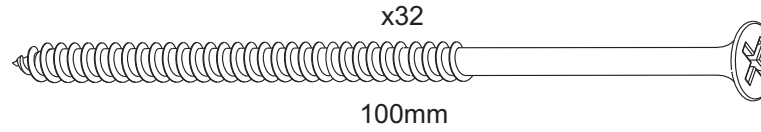

x32

100mm

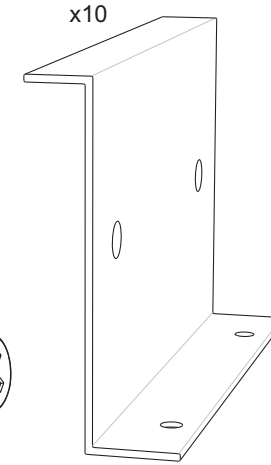

x10

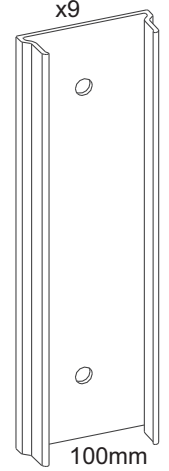

x9

100mm

A2



6.5mm



16mm

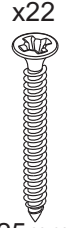

25mm

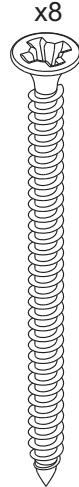

60mm

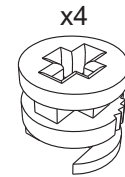

x4



x8

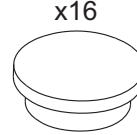

x16

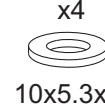

10x5.3x1

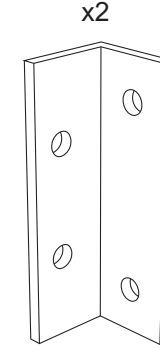

x2

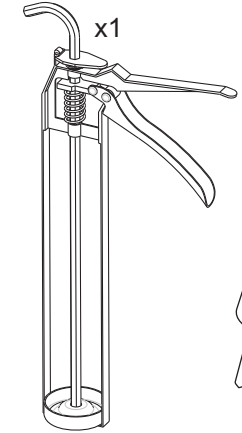

x1



x1



Ø 4.5

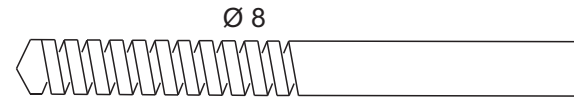

Ø 8

B

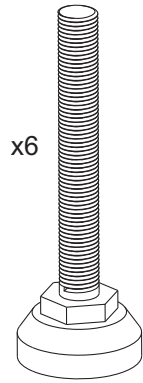
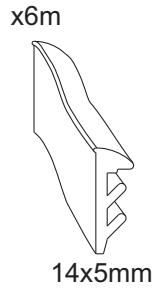
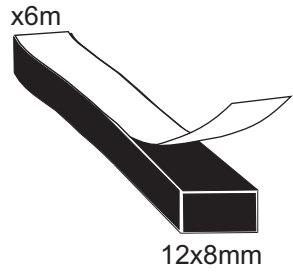

P1

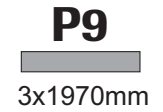
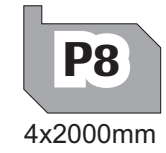
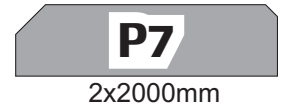
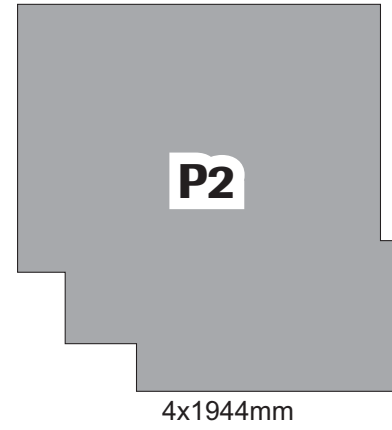
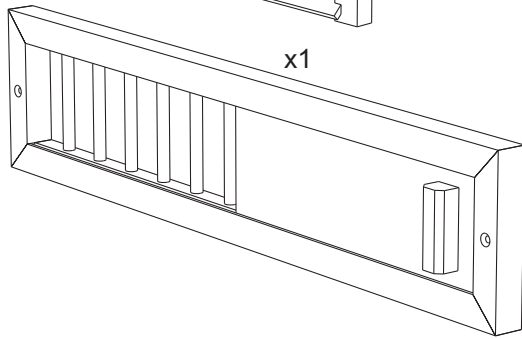
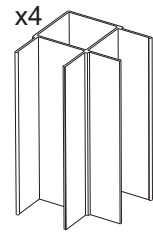
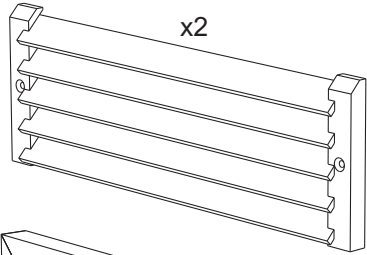

P9

3x1970mm

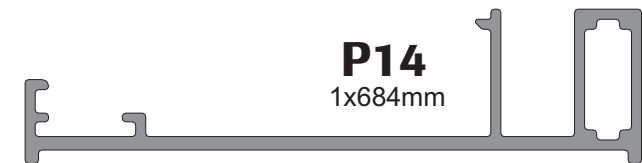
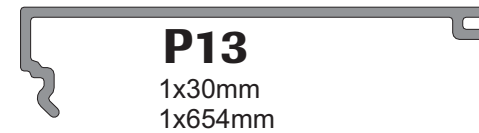
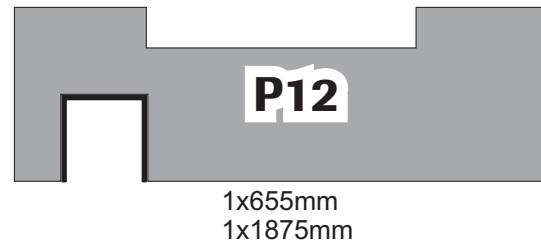
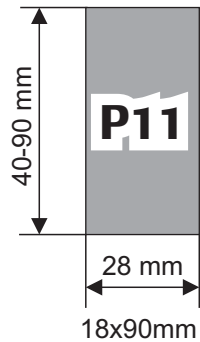
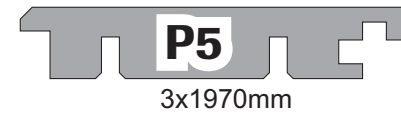
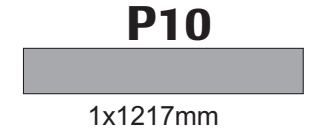
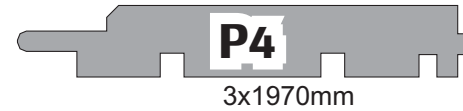

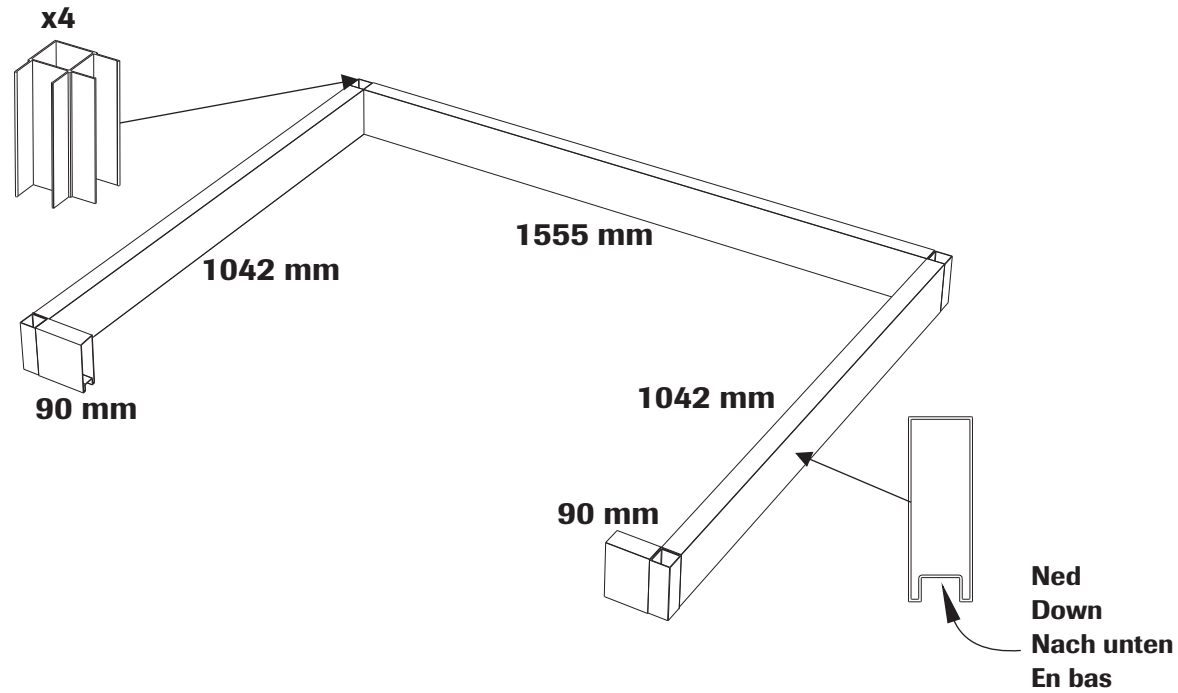
C**D**

Monteringsordning - väggar
 Assembly order - walls

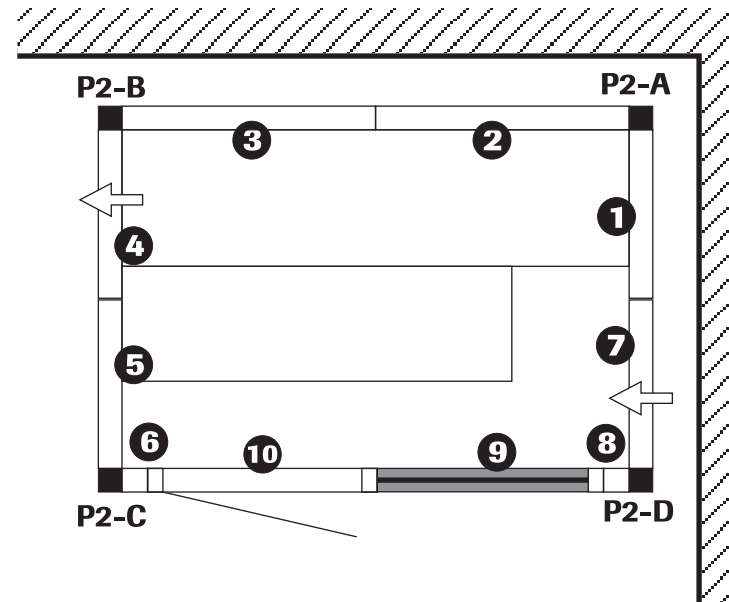
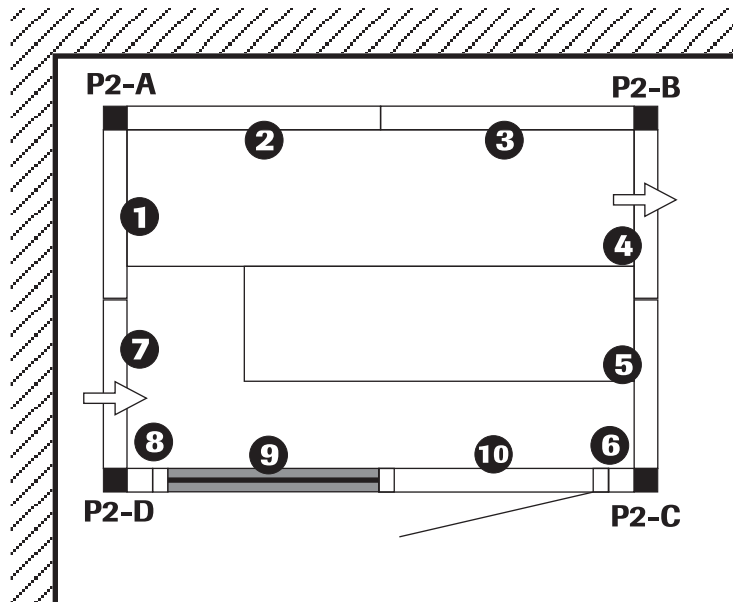

Väggyttermått
 Wall outer dimensions

| | |
|-------------------|--------|
| 1 4 5 7 | 506 mm |
| 2 3 | 762 mm |
| 6 8 | 77 mm |
| 9 (Glas/glass) | 685 mm |
| 10 (Dörr/door) | 690 mm |

E

Placering av skarvprofil.
Montering - se monteringsanvisning av rummet.

Location of the joint profile
Assembly - see installation instructions of the room.

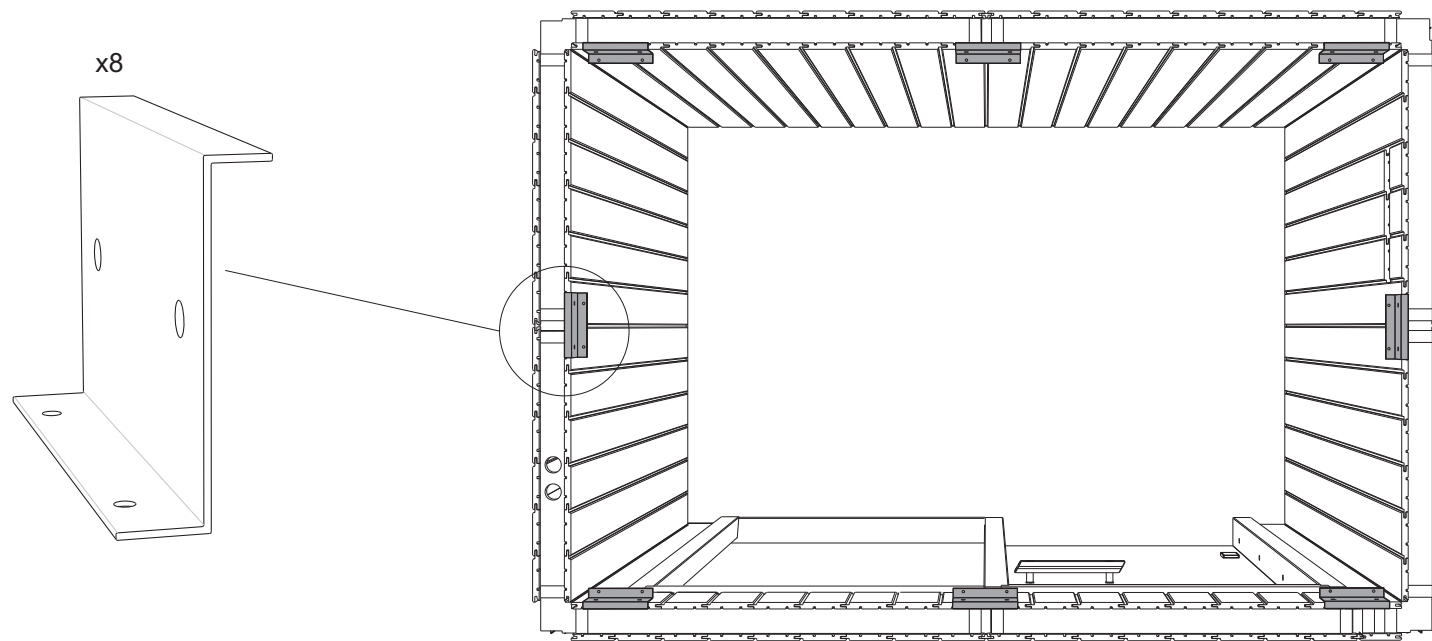

F Layouts 1712 PLUS GF

Standard

Layout 1

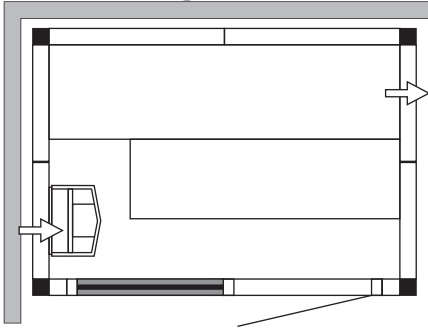

Layout 2

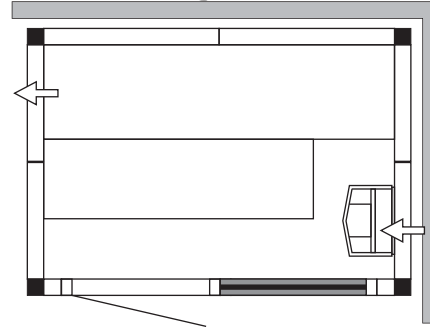

Layout 3

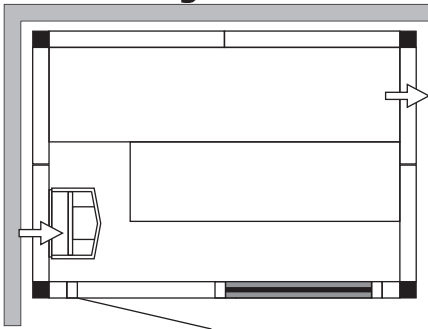

Layout 4

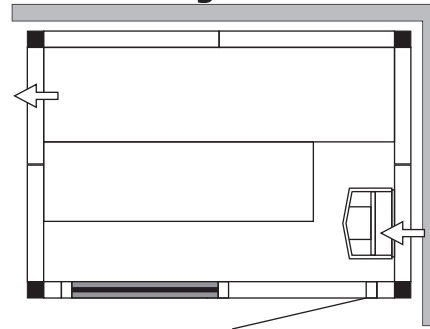

TYLÖ SAUNA E1717 PLUS GF

1202

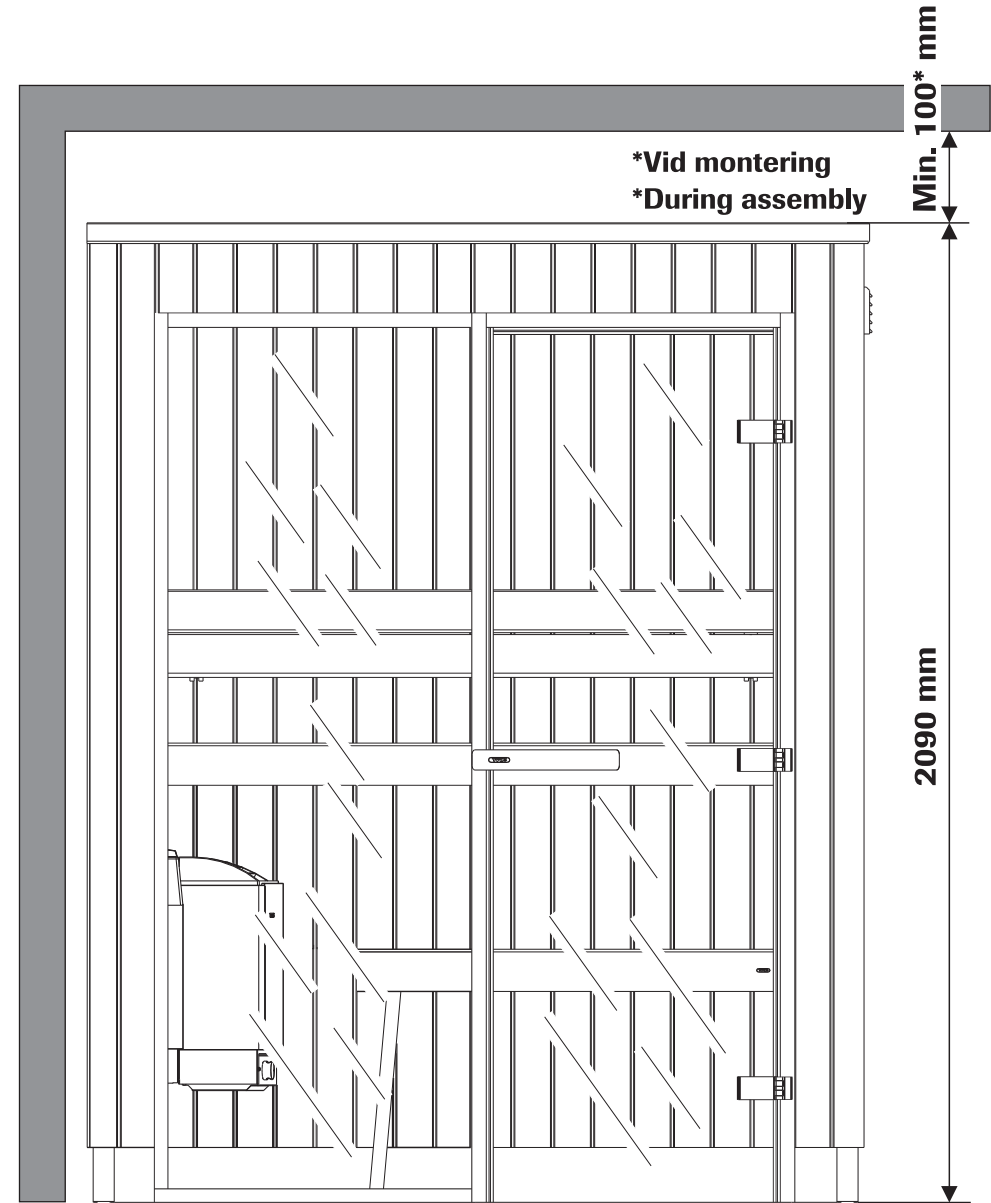
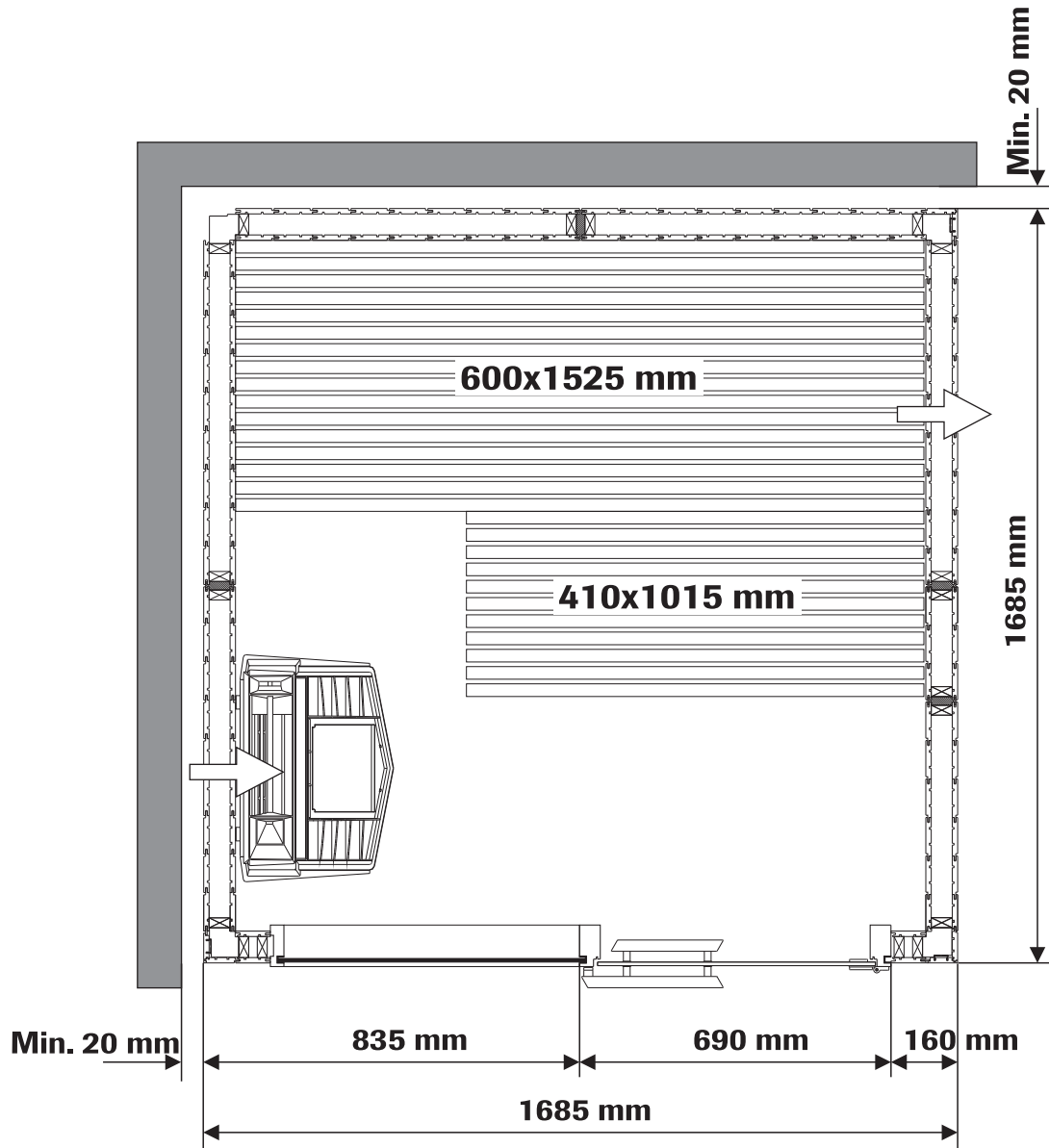

Art.nr 2900 4321

TYLÖ[®]
for the senses

A1

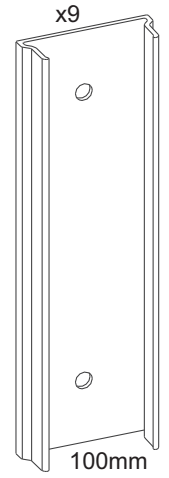
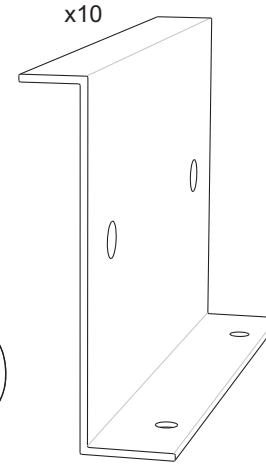
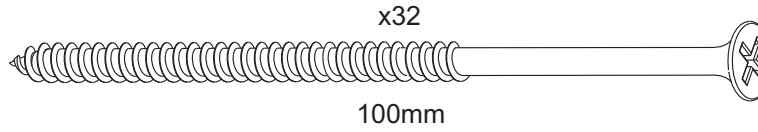
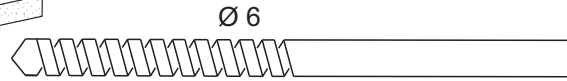
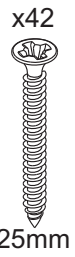
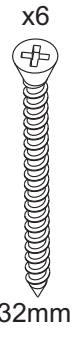
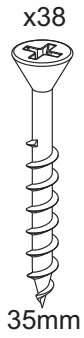
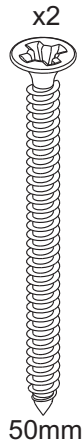
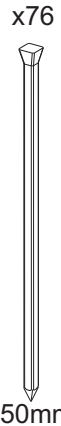
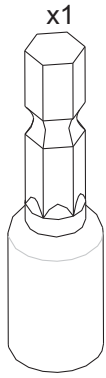

A2

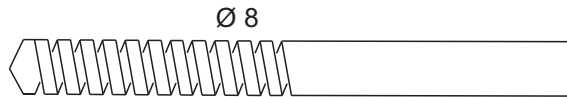
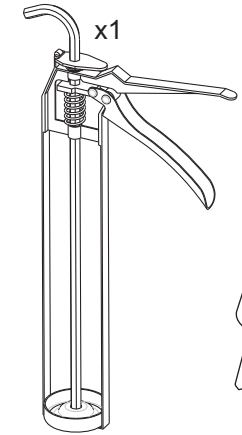
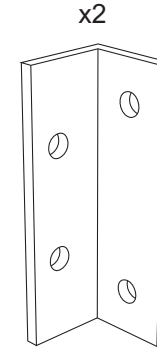
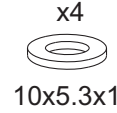
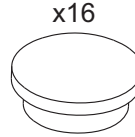
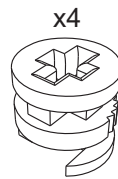
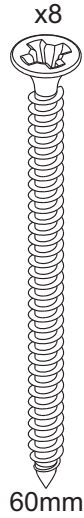
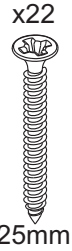
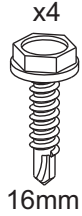

B

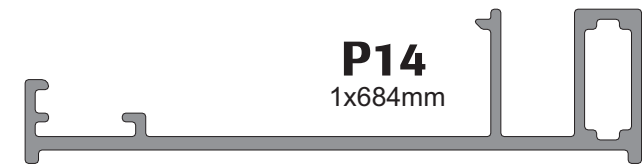
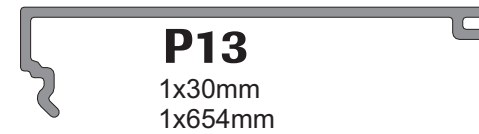
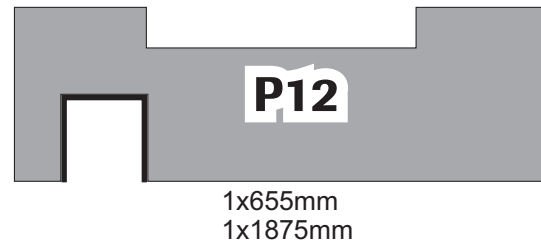
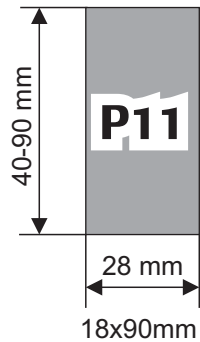
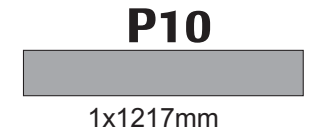
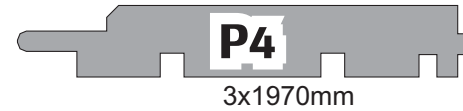
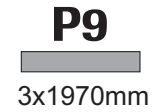
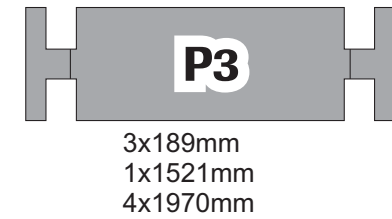
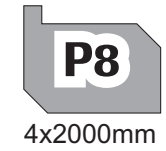
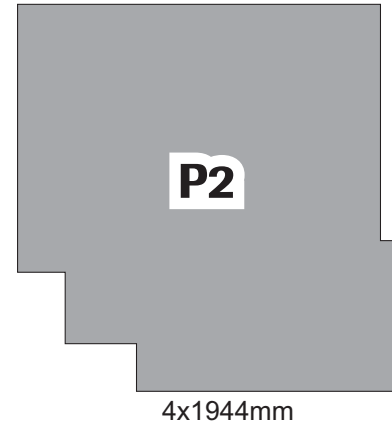
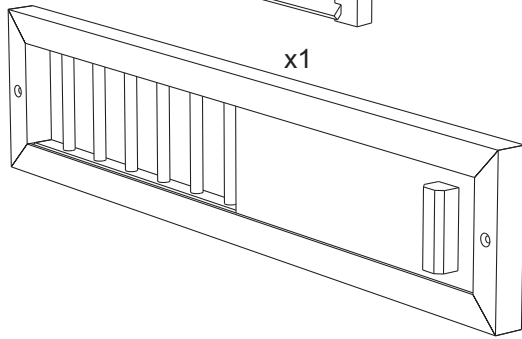
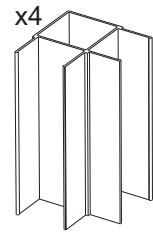
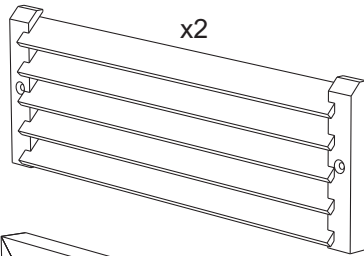
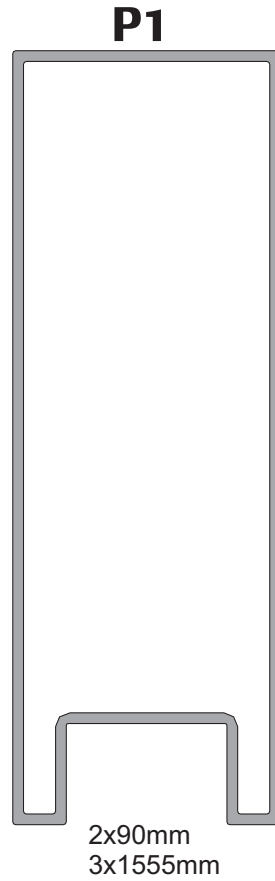
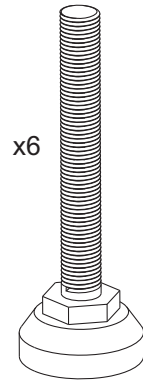
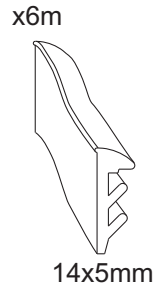
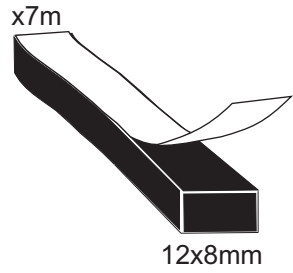

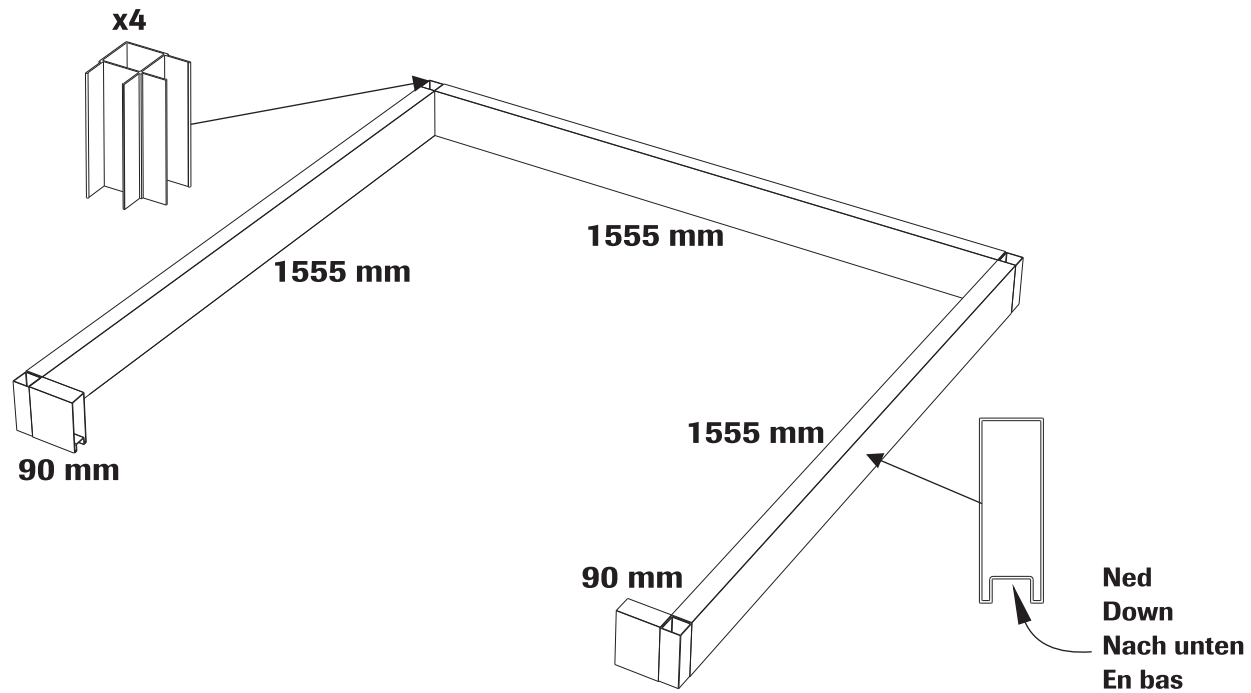
C**D**

Monteringsordning - väggar
Assembly order - walls

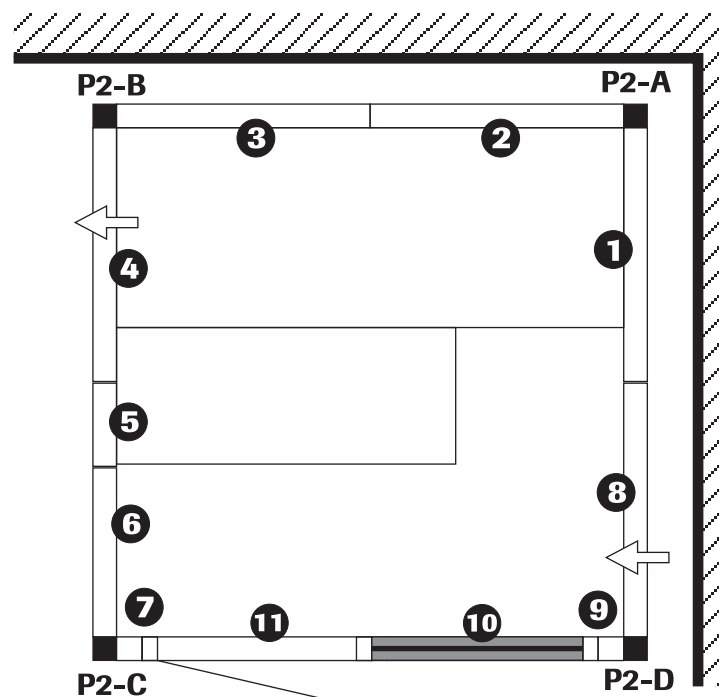
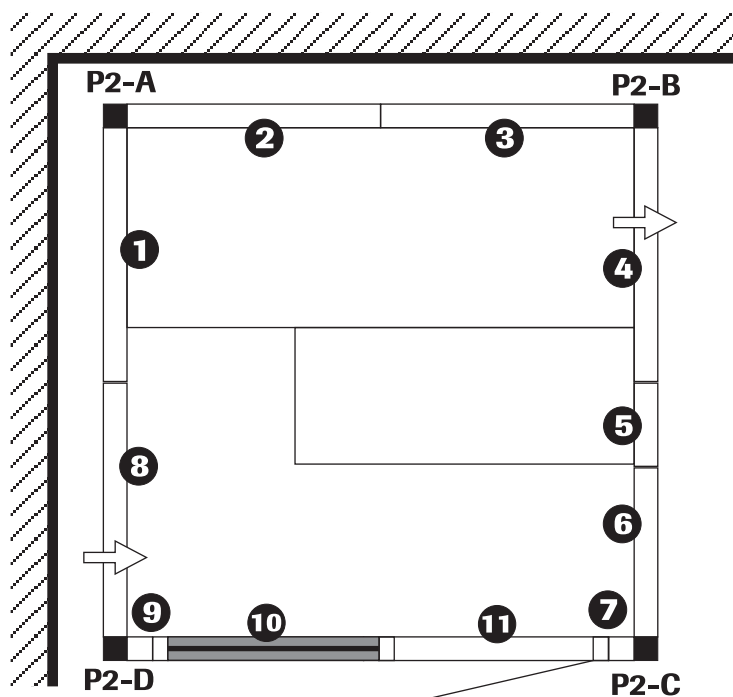

Väggyttermått
Wall outer dimensions

| | |
|--------------------|--------|
| 1 2 3 4 8 | 762 mm |
| 6 | 506 mm |
| 5 | 250 mm |
| 7 9 | 77 mm |
| 10 (Glas/glass) | 685 mm |
| 11 (Dörr/door) | 690 mm |

E

Placering av skarvprofil.
Montering - se monteringsanvisning av rummet.

Location of the joint profile
Assembly - see installation instructions of the room.

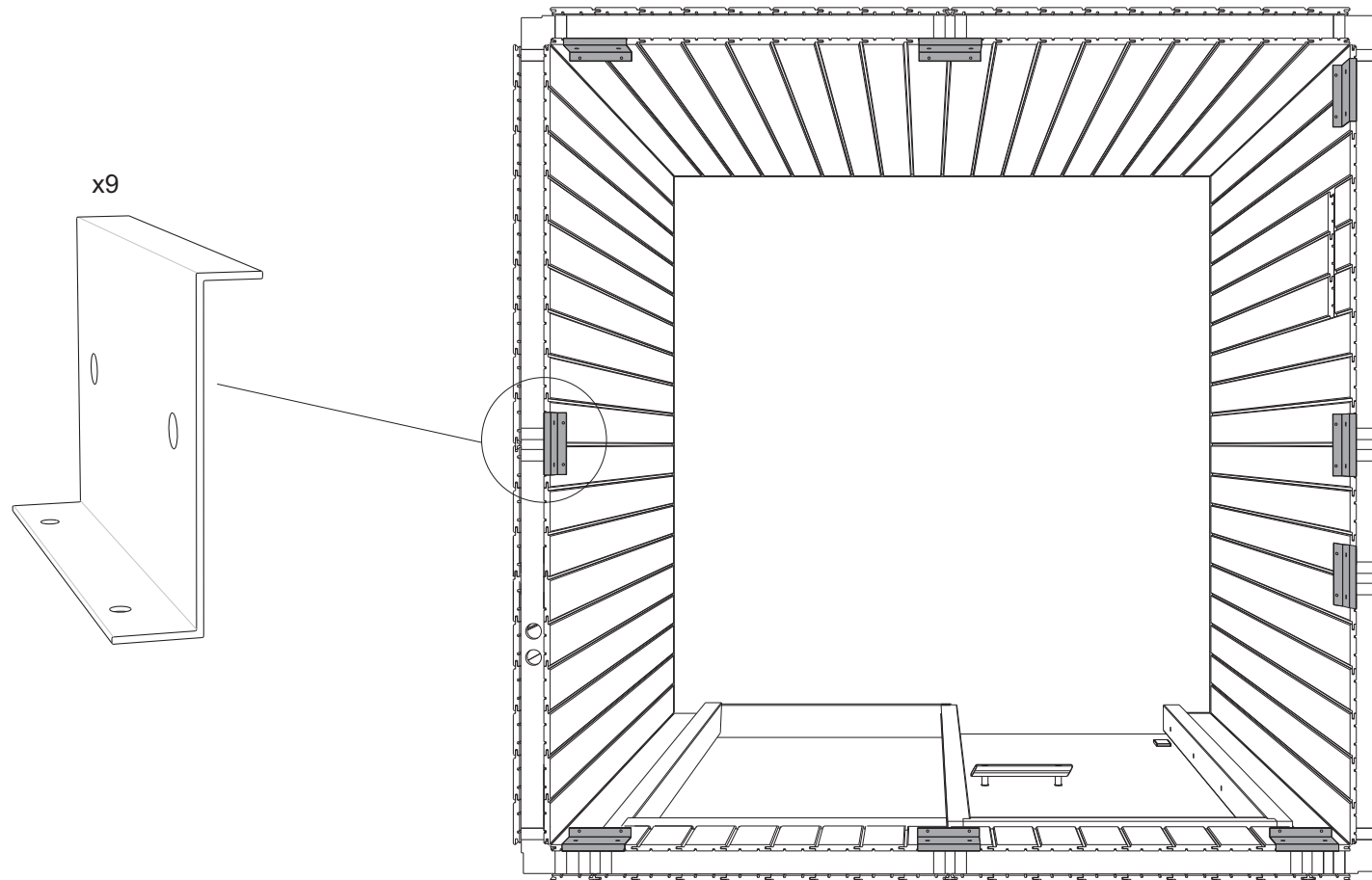

F Layouts 1717 PLUS GF G = Glass

Standard

Layout 1

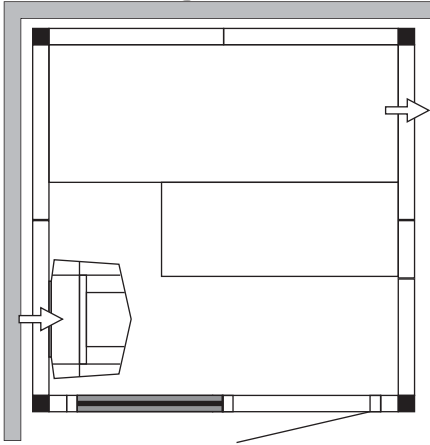

Layout 2

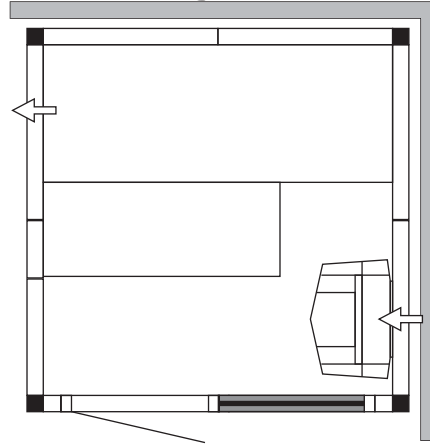

Standard with optional glass section.

Layout 3

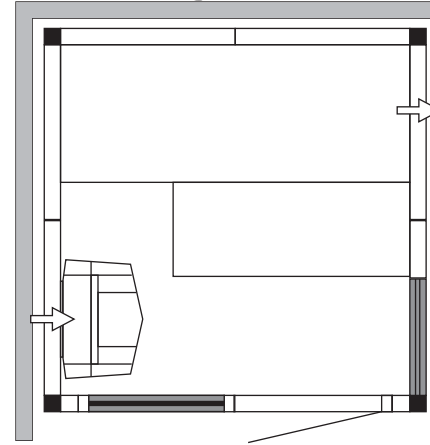

Layout 4

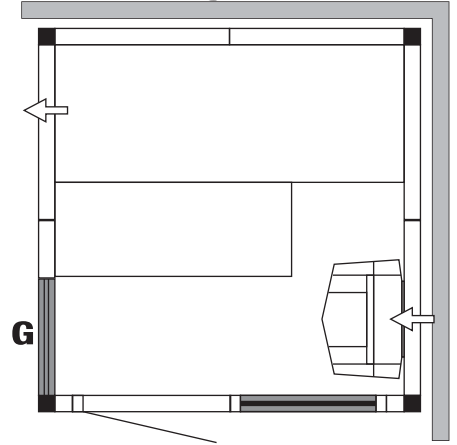

TYLÖ SAUNA E1917 PLUS GF

1202

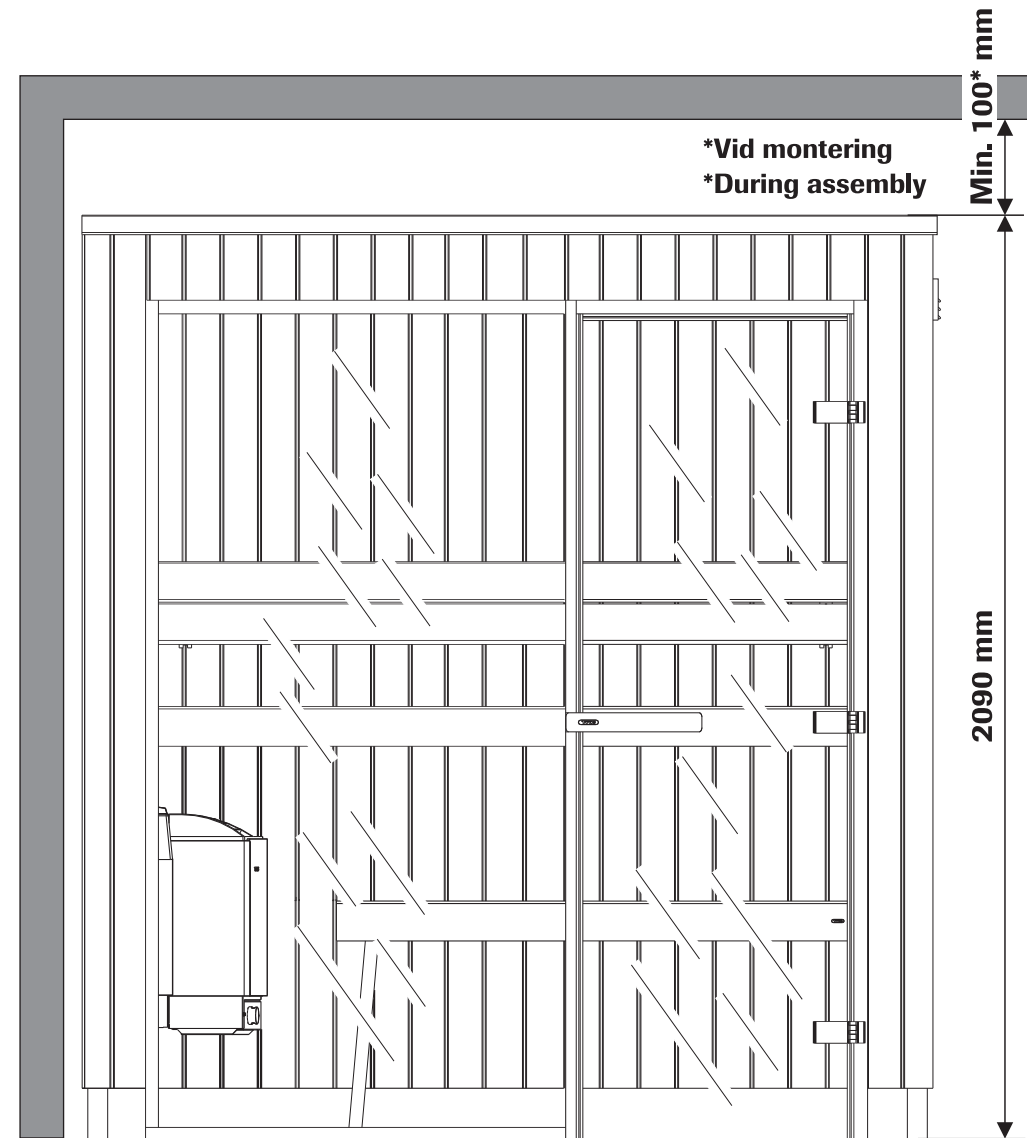
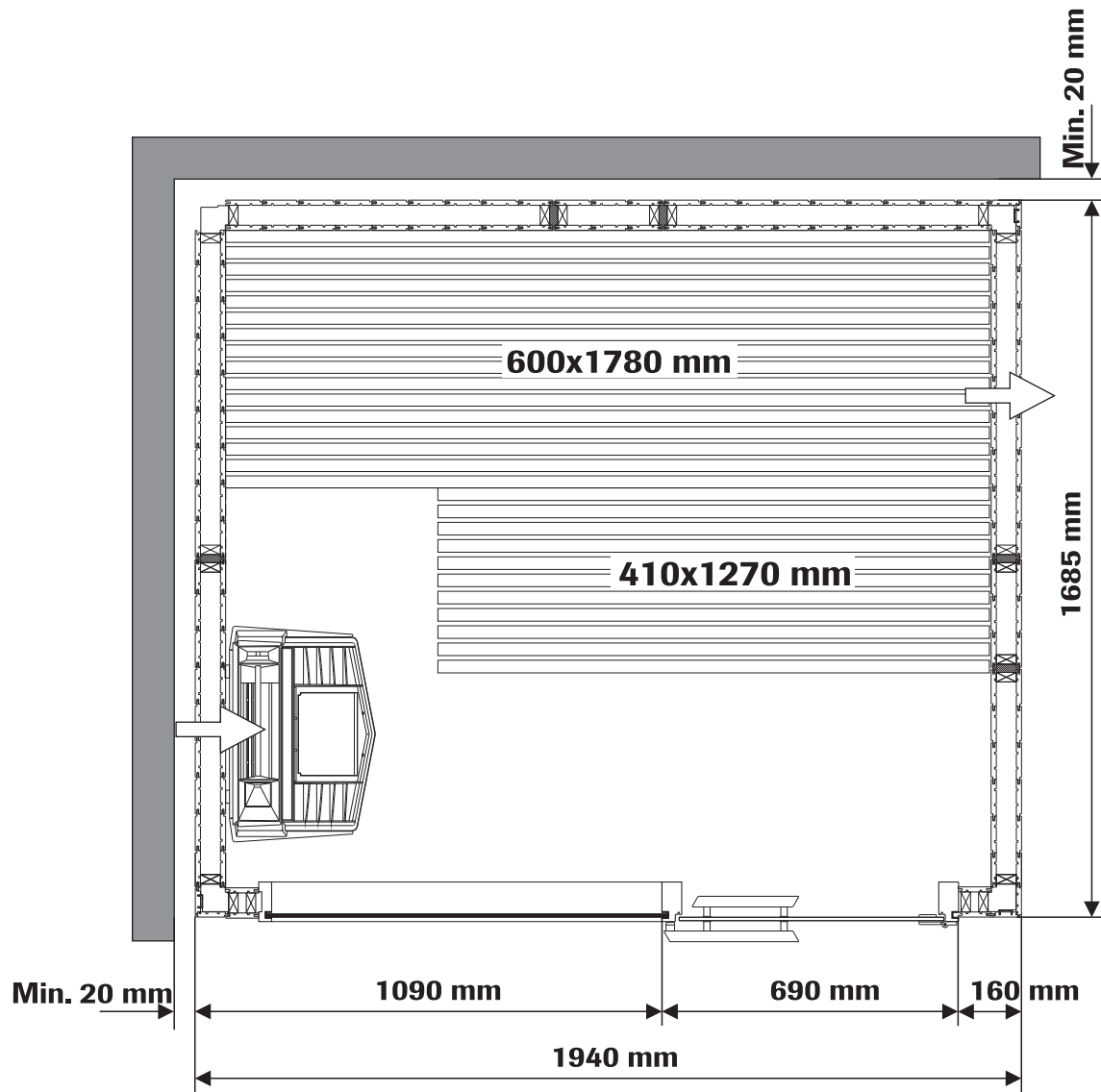

Art.nr 2900 4331

TYLÖ[®]
for the senses

A1

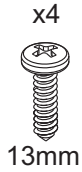
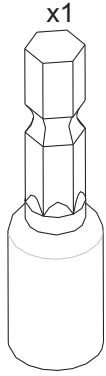

13mm

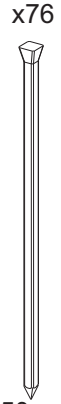

50mm

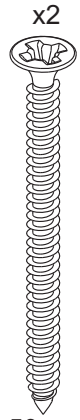

50mm

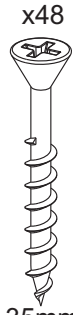

35mm

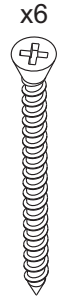

32mm



25mm



Ø 2



Ø 3.5

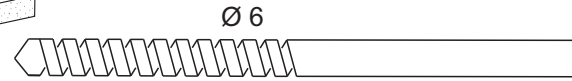

Ø 6

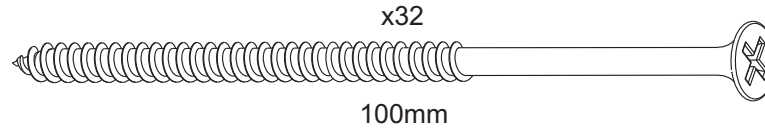

x32

100mm

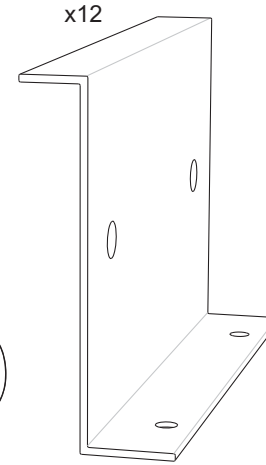

x12

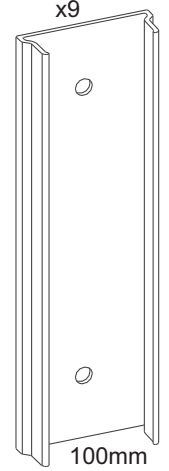

x9

100mm

A2



6.5mm



16mm

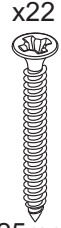

25mm

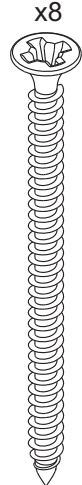

60mm

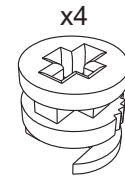

x4



x8

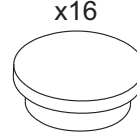

x16

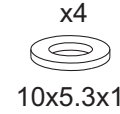

10x5.3x1

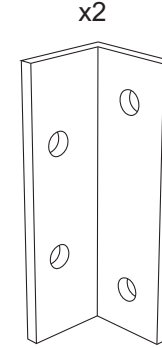

x2

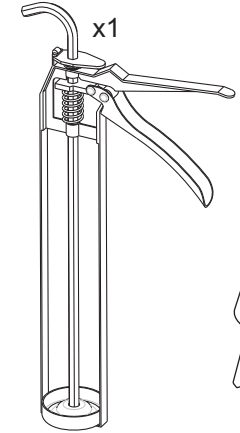

x1



x1



Ø 4.5

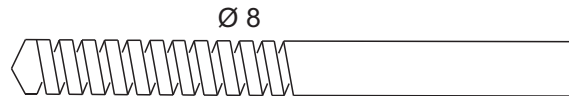

Ø 8

B

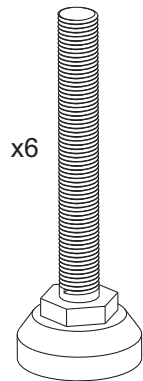
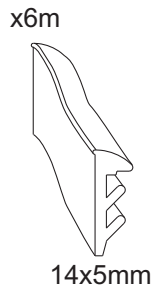
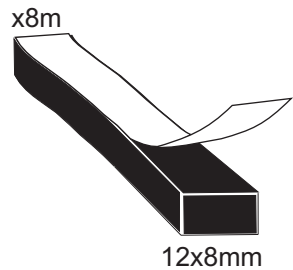

P1

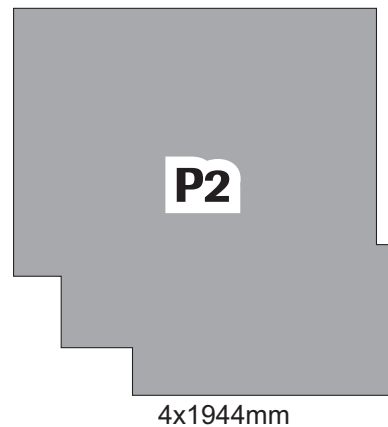
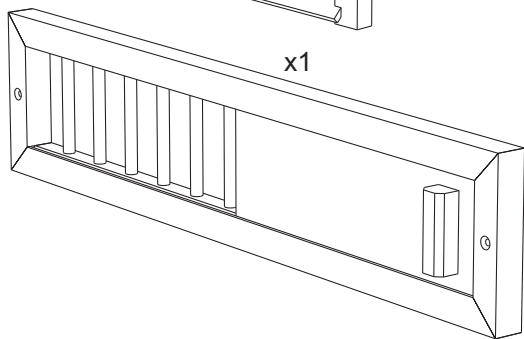
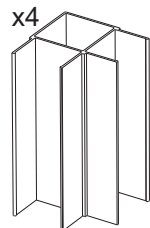
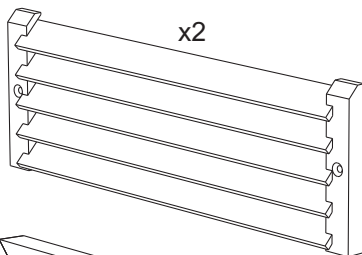

4x2000mm

P9

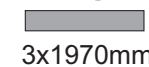

3x1970mm

P10



1x1217mm



P3

4x189mm
2x1521mm
5x1970mm



P4

3x1970mm



P5

3x1970mm

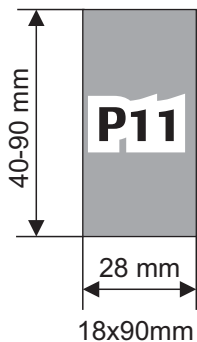

1x908mm
1x1875mm



P13

1x30mm
1x908mm

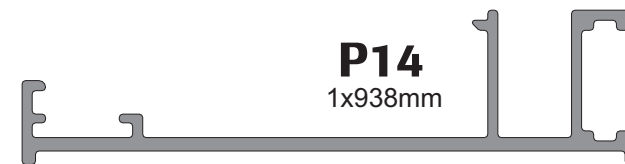

P14

1x938mm

C

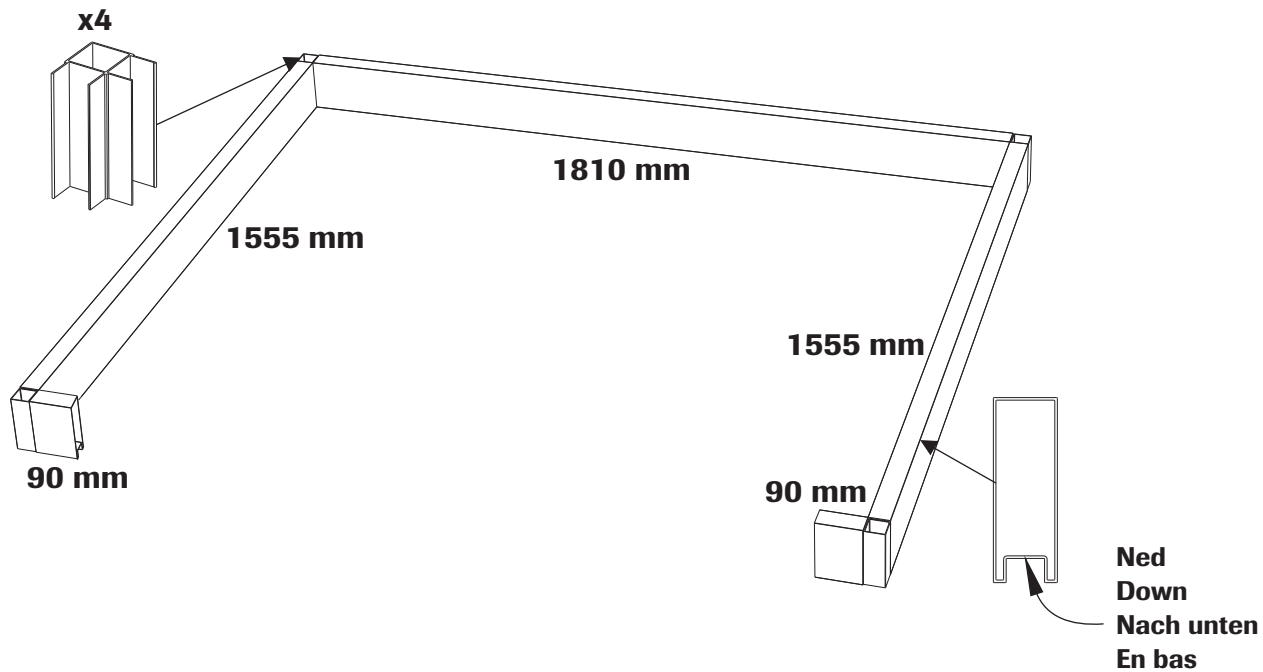

D

Monteringsordning - väggar
Assembly order - walls

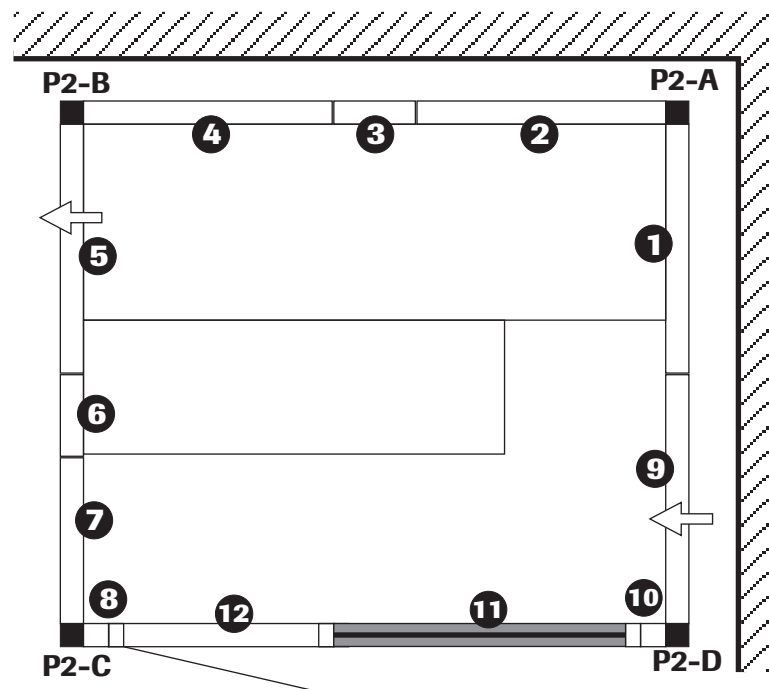
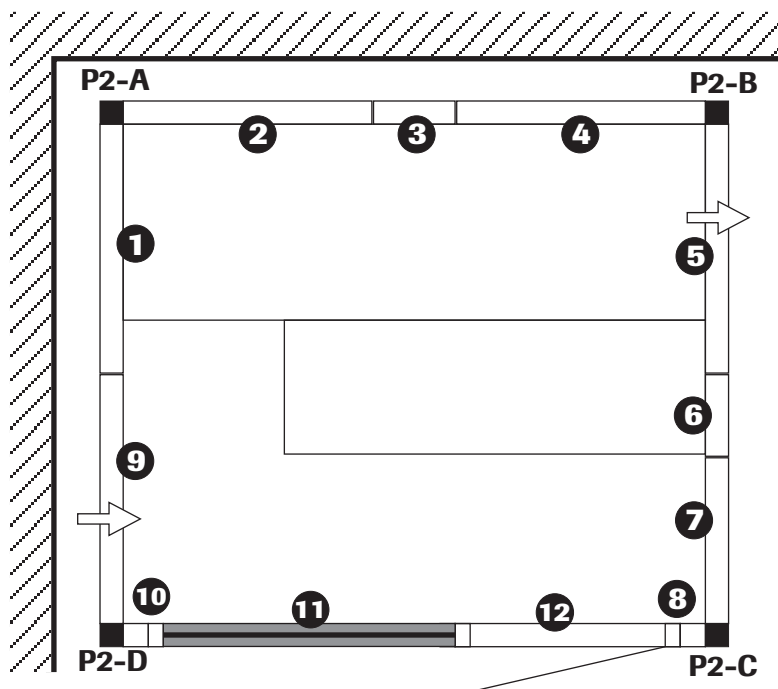

Väggytermått
Wall outer dimensions

| | |
|--------------------|--------|
| 1 2 4 | 762 mm |
| 5 9 | |
| 7 | 506 mm |
| 3 6 | 250 mm |
| 8 10 | 77 mm |
| 11 (Glas/glass) | 938 mm |
| 12 (Dörr/door) | 690 mm |

E

Placering av skarvprofil.
Montering - se monteringsanvisning av rummet.

Location of the joint profile
Assembly - see installation instructions of the room.

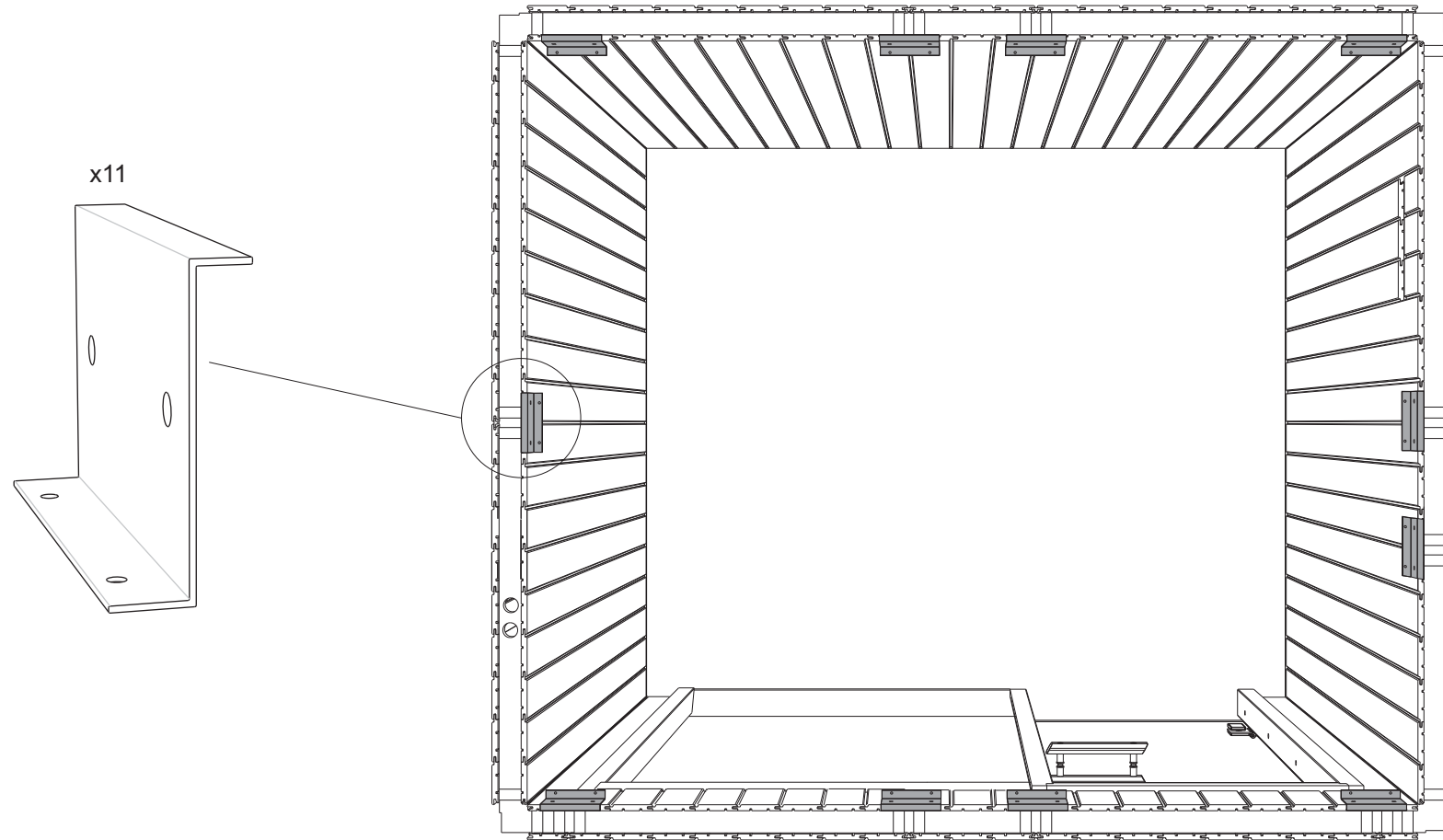

F Layouts 1917 PLUS GF

G = Glass

Standard

Layout 1

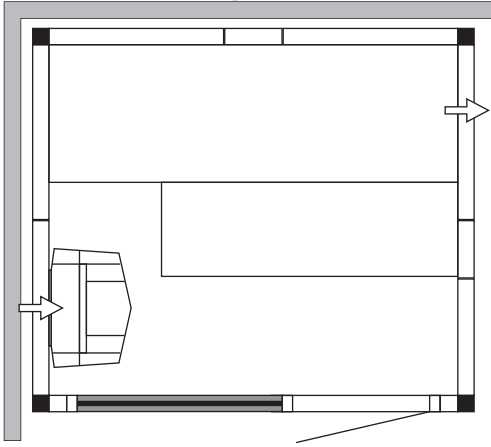

Layout 2

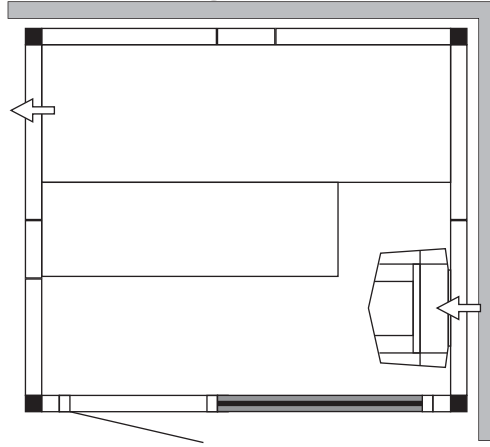

Standard with optional glass section

Layout 3

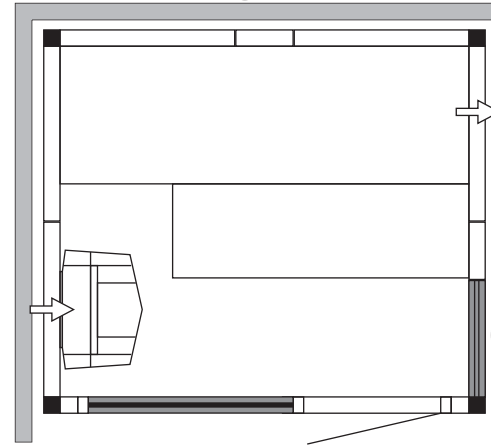

Layout 4

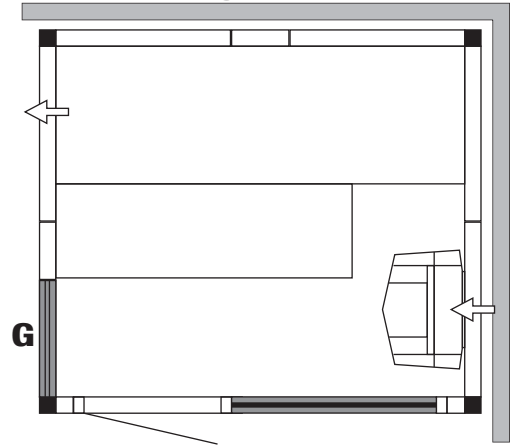

TYLÖ SAUNA E1919 PLUS GF

1202

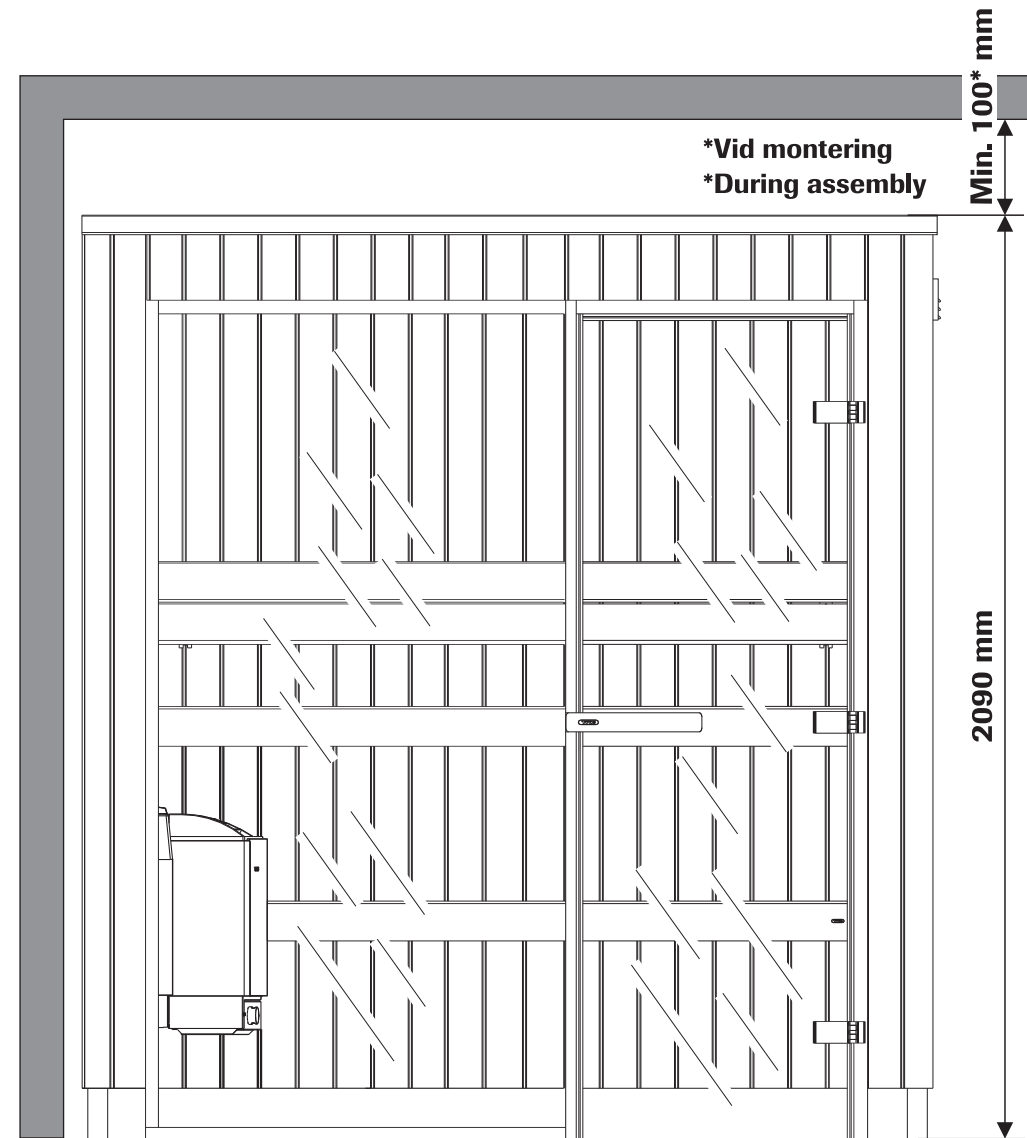
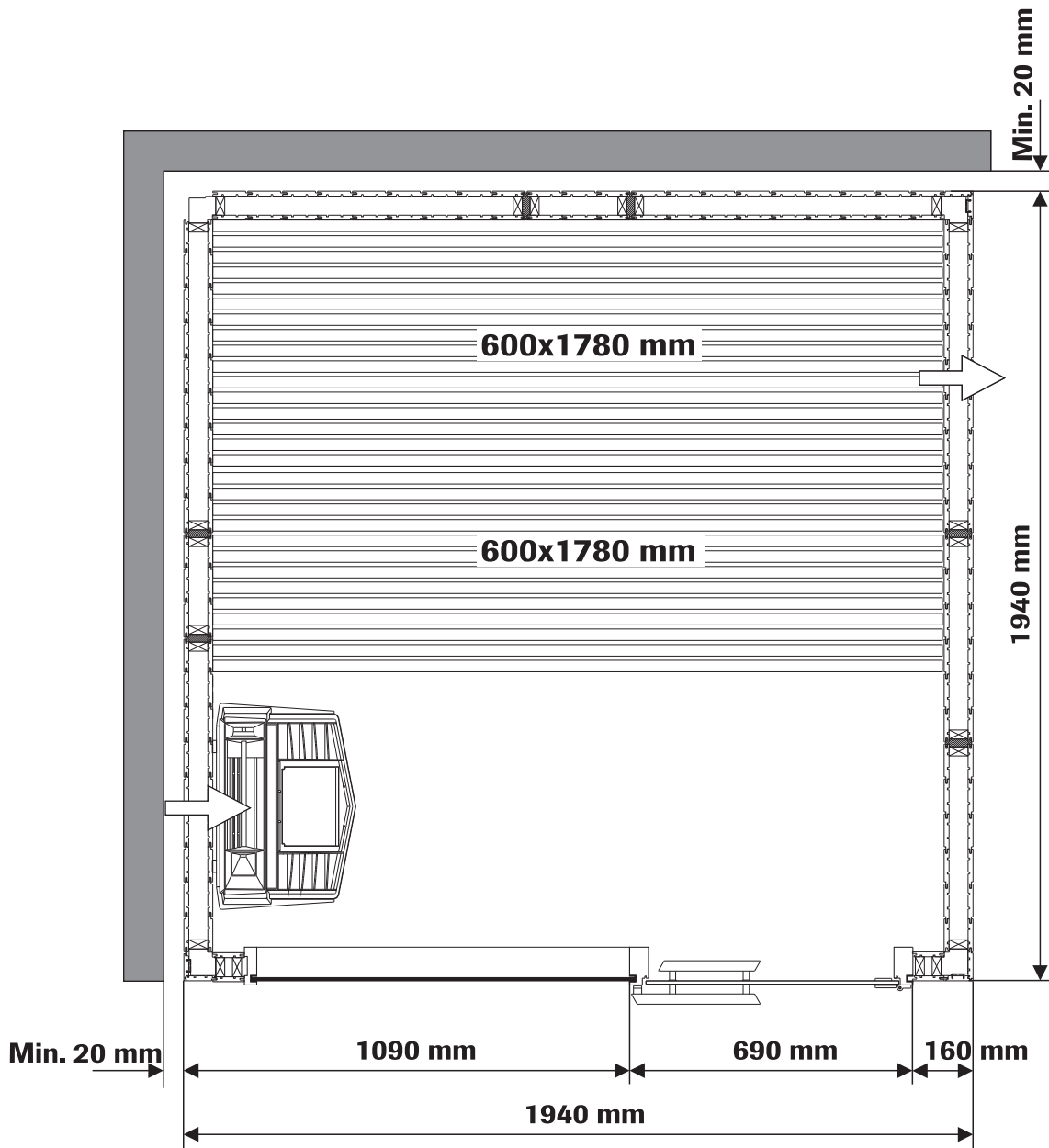

Art.nr 2900 4341

TYLÖ[®]
for the senses

A1

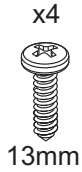
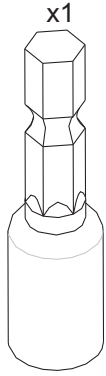

13mm

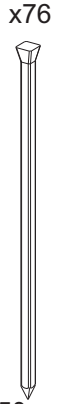

50mm

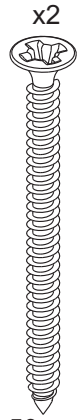

50mm

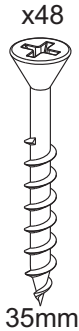

35mm



32mm

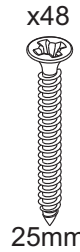

25mm

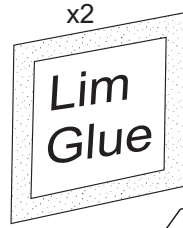

Lim
Glue



Ø 2



Ø 3.5

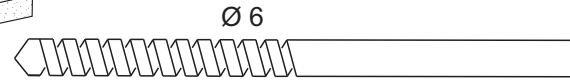

Ø 6

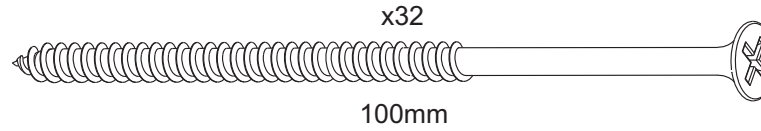

x32

100mm

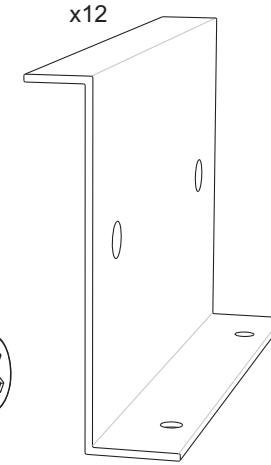

x12

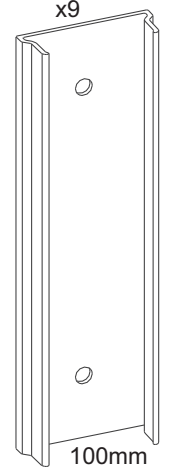

x9

100mm

A2



6.5mm



16mm

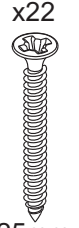

25mm

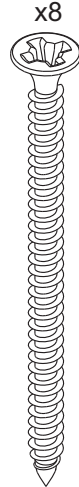

60mm

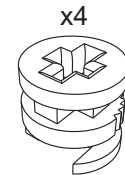
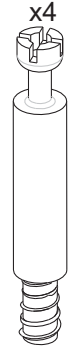

x4

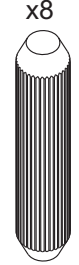

x8

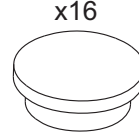

x16

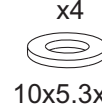

10x5.3x1

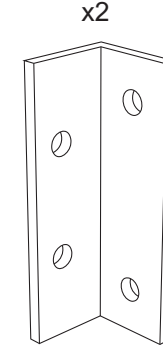

x2

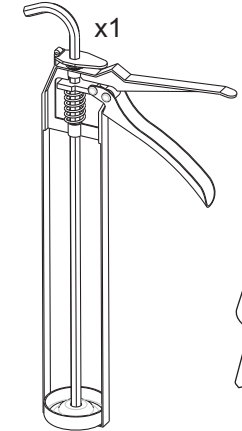

x1



x1



Ø 4.5

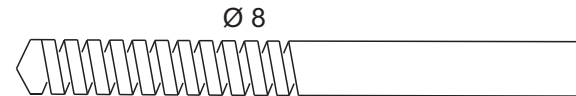

Ø 8

B

x8m

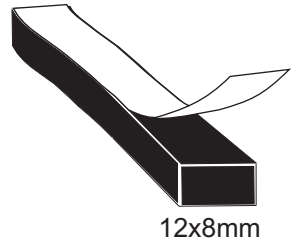

x6m

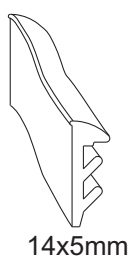

x6

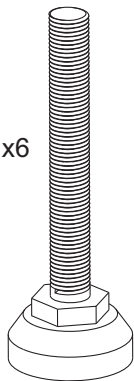
**P1**

2x90mm
2x1555mm
1x1810mm

x4

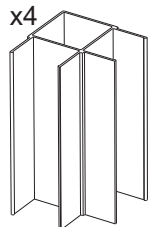

x2

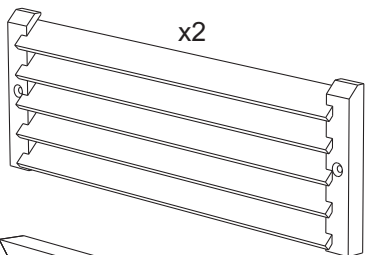

x1

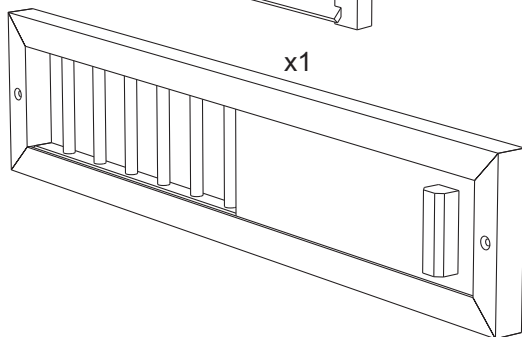
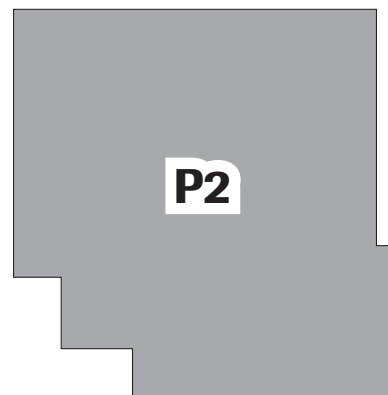
**P2**

4x1944mm

P6

2x1750mm

P7

2x2000mm

P8

4x2000mm

P9

3x1970mm

P10

1x1217mm

P3

4x189mm
2x1776mm
6x1970mm

P4

3x1970mm

P5

3x1970mm

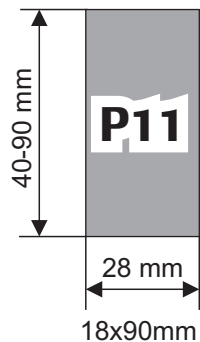
**P12**

1x908mm
1x1875mm

P13

1x30mm
1x908mm

**P14**

1x938mm

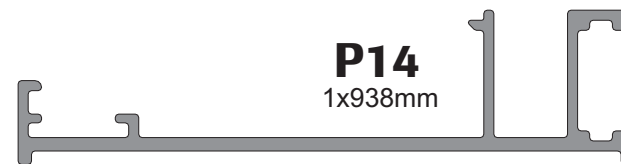

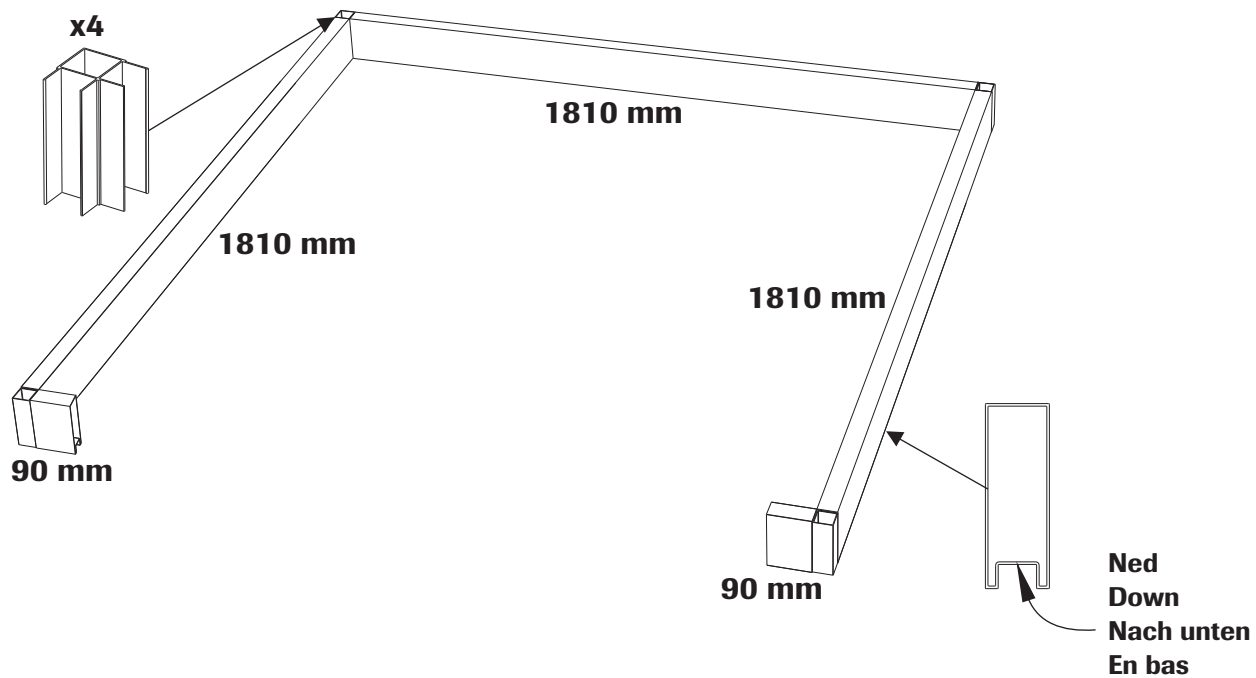
C**D**

Monteringsordning - väggar
 Assembly order - walls

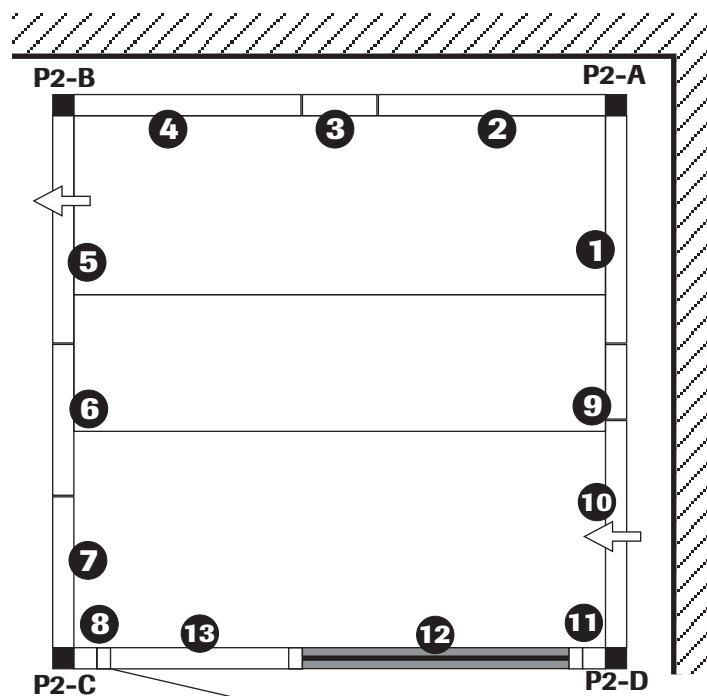
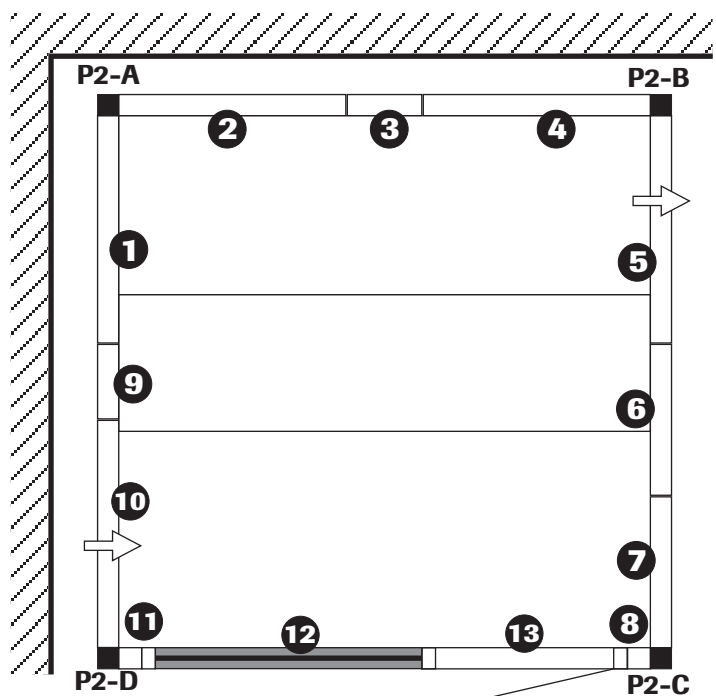

Väggyttermått
 Wall outer dimensions

| | |
|--------------------|--------|
| 1 2 4 5 10 | 762 mm |
| 6 7 | 506 mm |
| 3 9 | 250 mm |
| 8 11 | 77 mm |
| 12 (Glas/glass) | 938 mm |
| 13 (Dörr/door) | 690 mm |

E

Placering av skarvprofil.
Montering - se monteringsanvisning av rummet.

Location of the joint profile
Assembly - see installation instructions of the room.

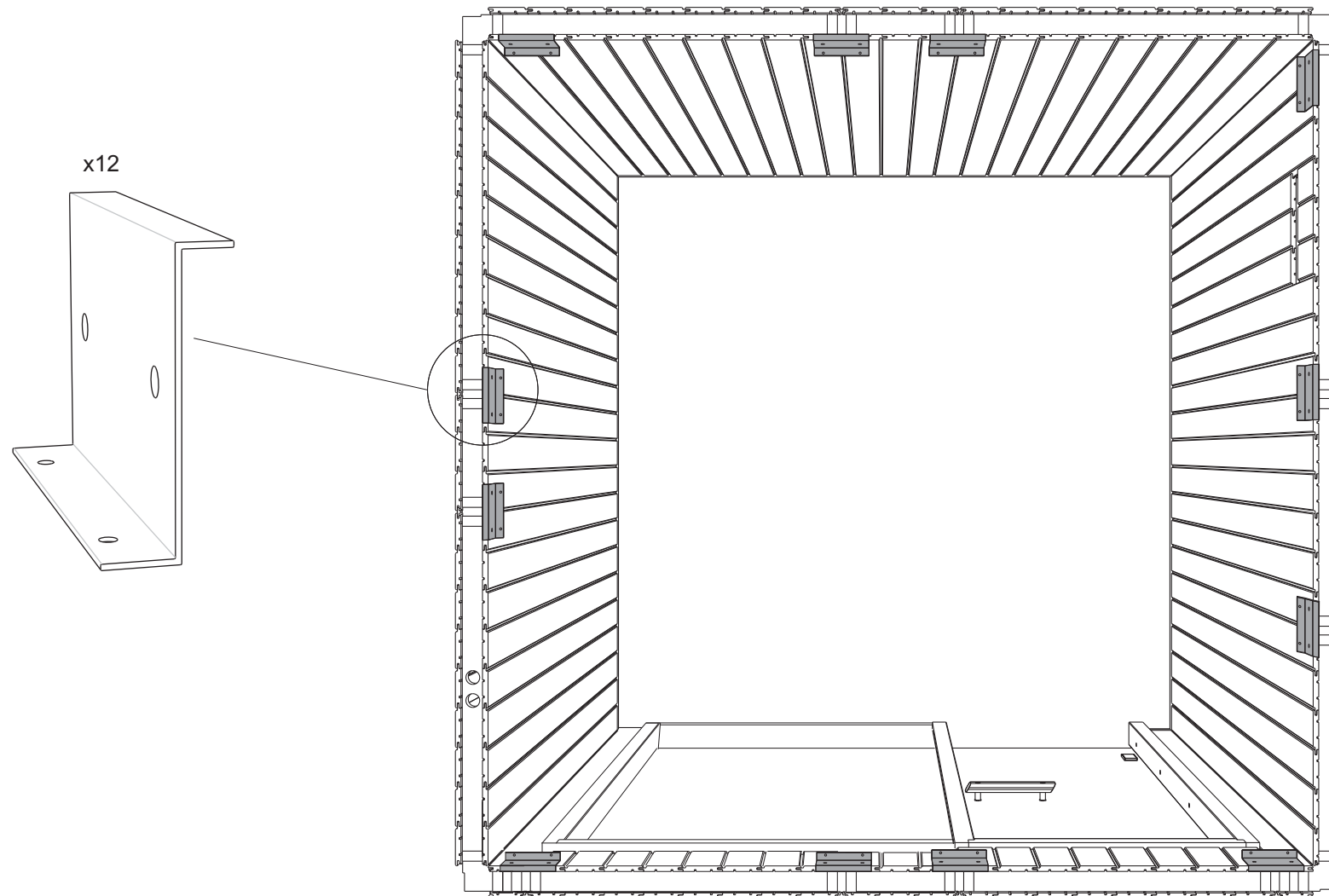

F Layouts 1919 PLUS GF

G = Glass

Standard

Layout 1

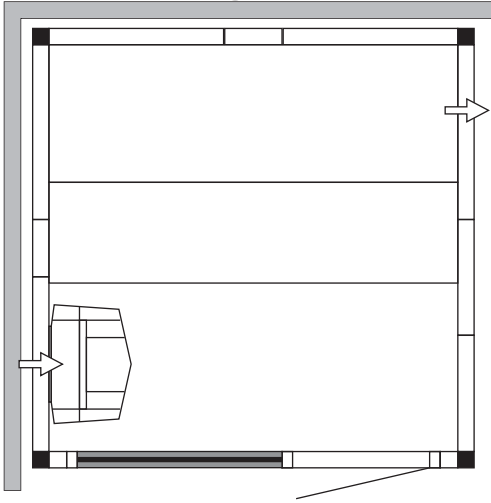

Layout 2

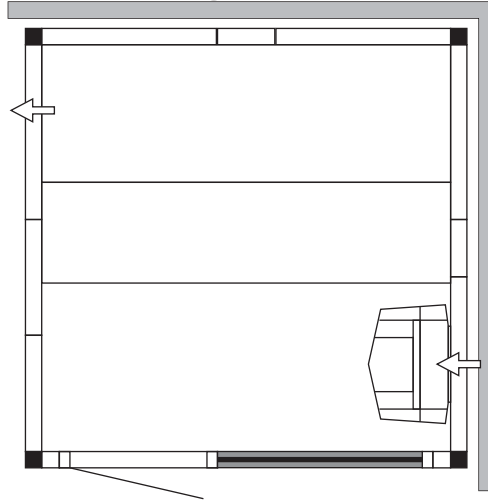

Standard with optional glass section

Layout 3

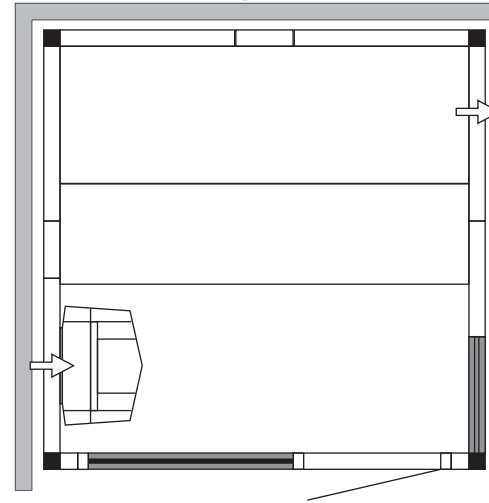

Layout 4

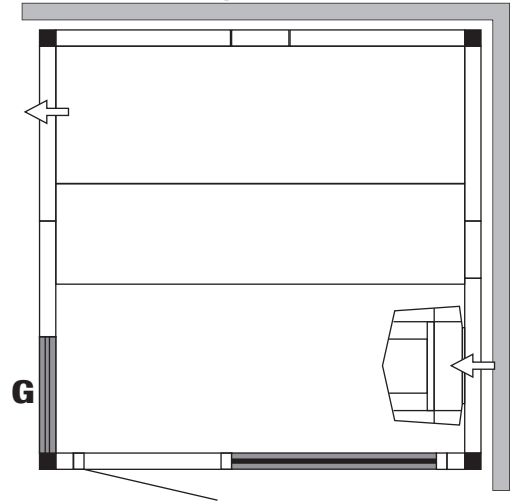

TYLÖ SAUNA E2217 PLUS GF

1202

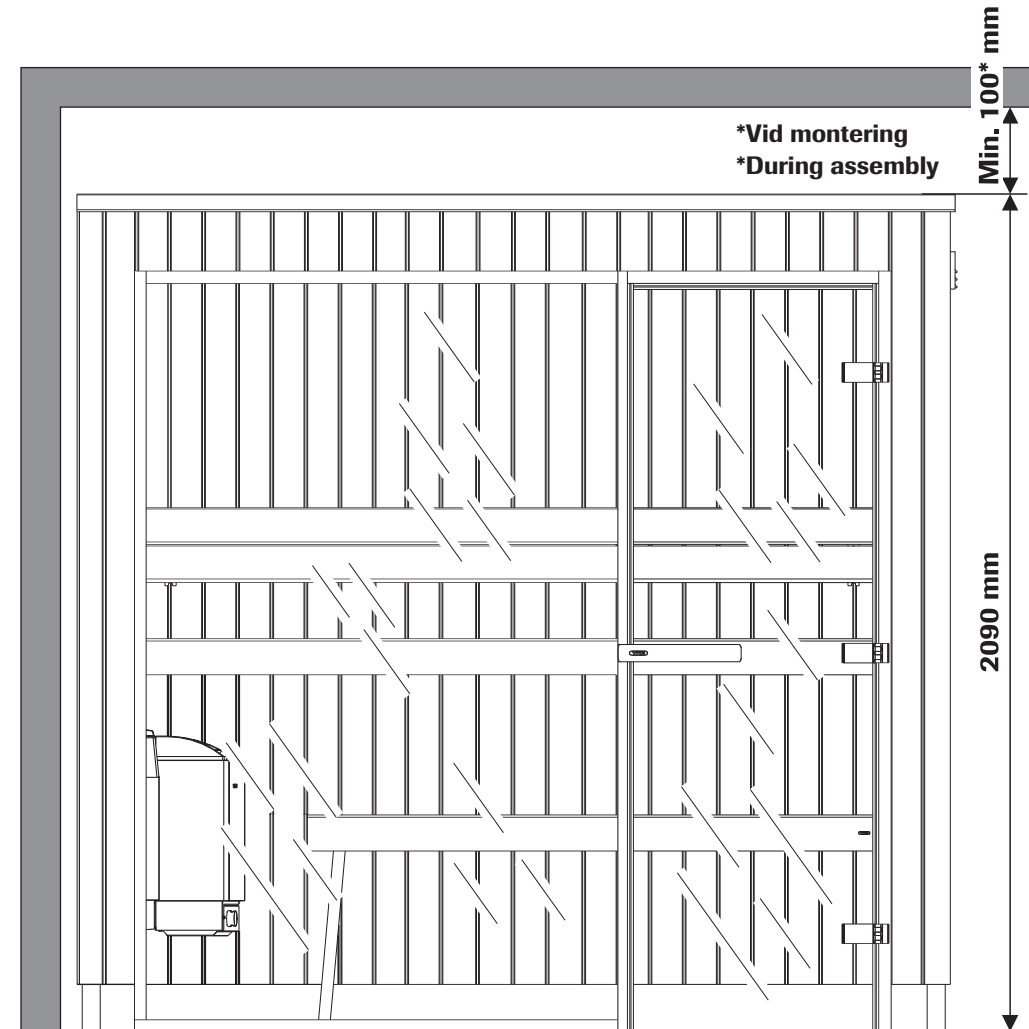
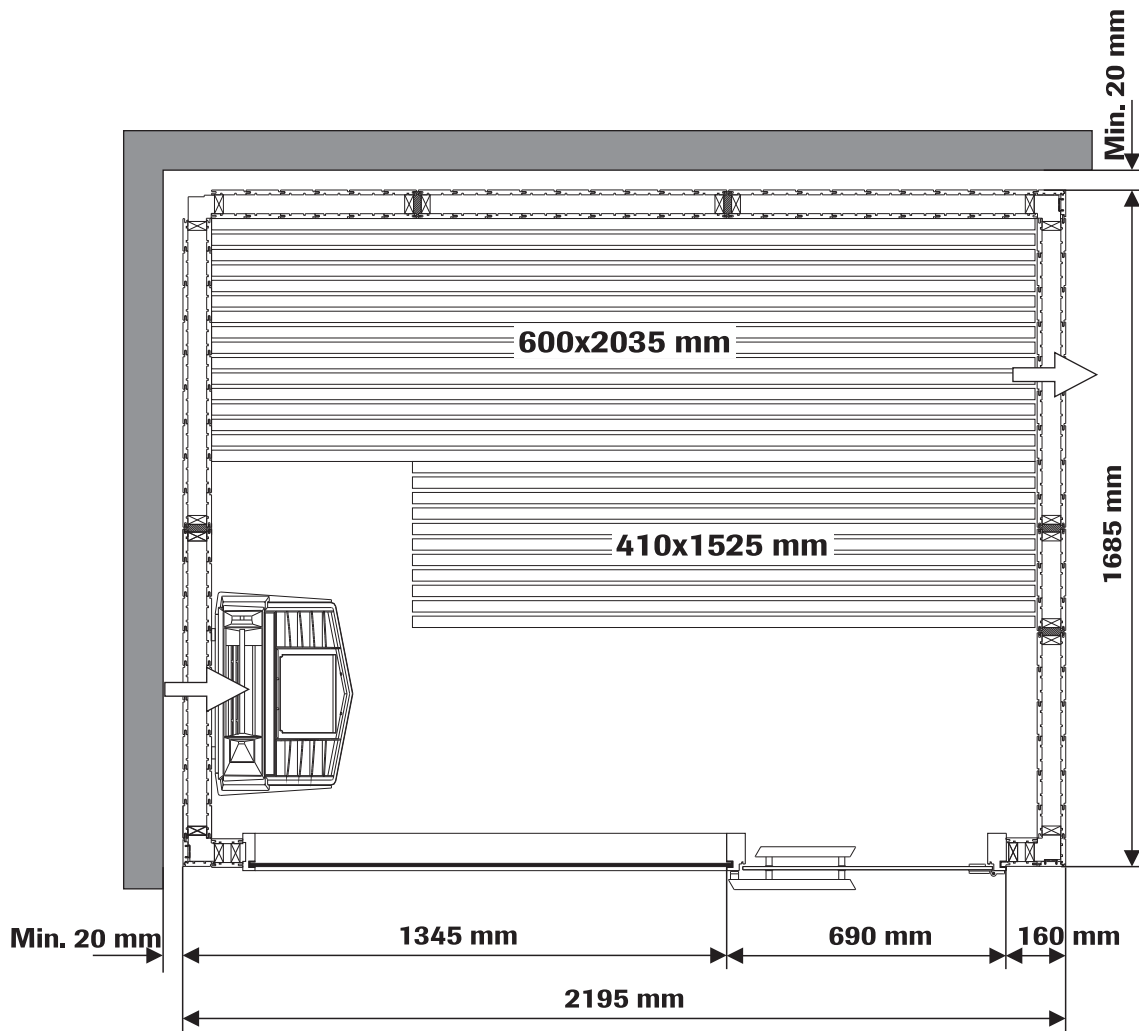

Art.nr 2900 4351

TYLÖ[®]
for the senses

A1

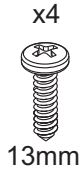
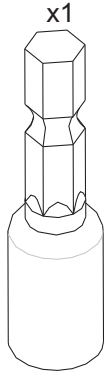

13mm

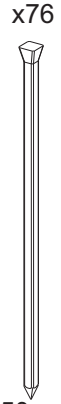

50mm

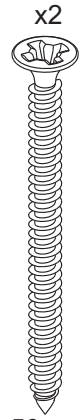

50mm

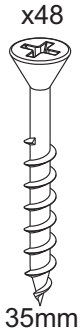

35mm



32mm

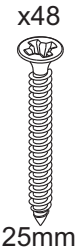

25mm



Lim
Glue

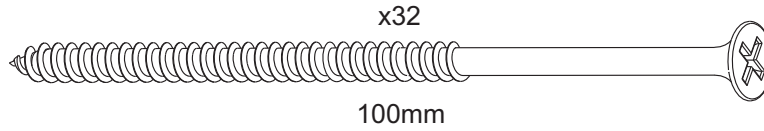

100mm

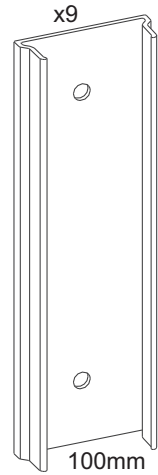
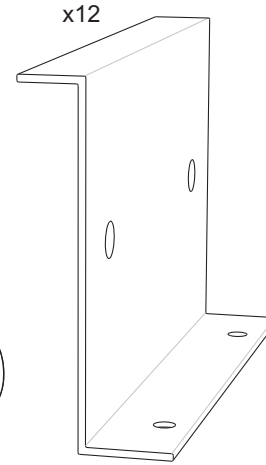

100mm

A2



6.5mm



16mm

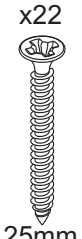

25mm

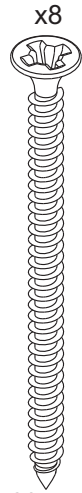

60mm

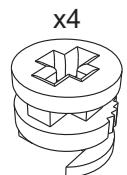

x4

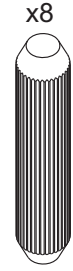

x8

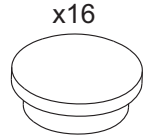

x16

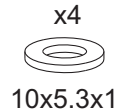

10x5.3x1

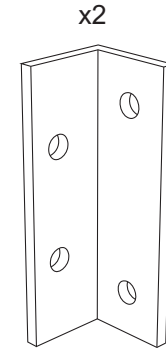

x2

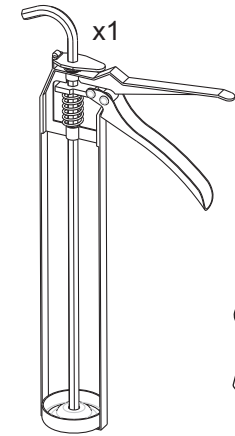

x1



x1

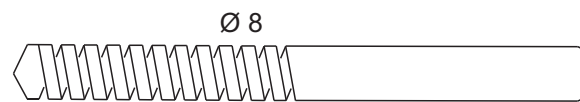
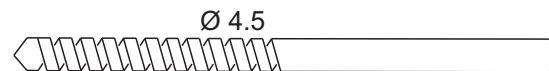

B

x8m

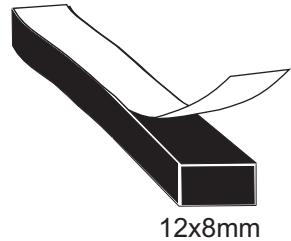

x7m

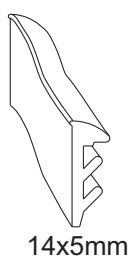

x6

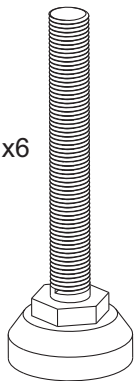
**P1**

2x90mm
2x1555mm
1x2066mm

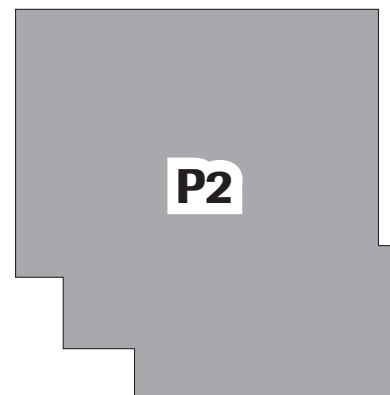
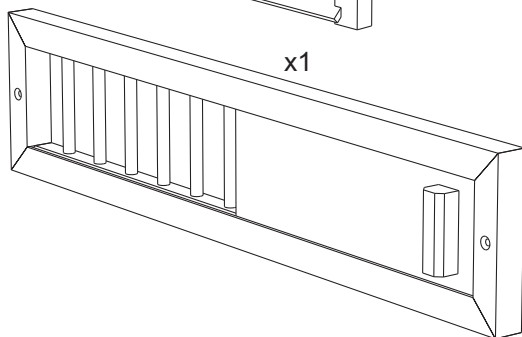
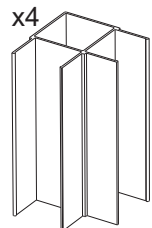
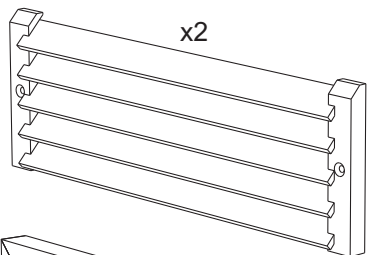
**P2**

4x1944mm

**P3**

4x189mm
2x1521mm
5x1970mm

**P4**

3x1970mm

**P5**

3x1970mm

**P6**

3x1750mm

**P7**

1x2000mm
1x2200mm

**P8**

2x2000mm
2x2100mm

P9

3x1970mm

**P10**

1x1217mm

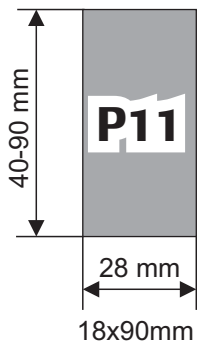
**P12**

1x1164mm
1x1875mm

**P13**

1x30mm
1x1164mm

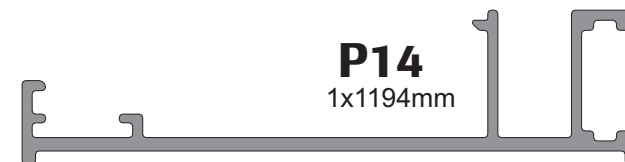
**P14**

1x1194mm

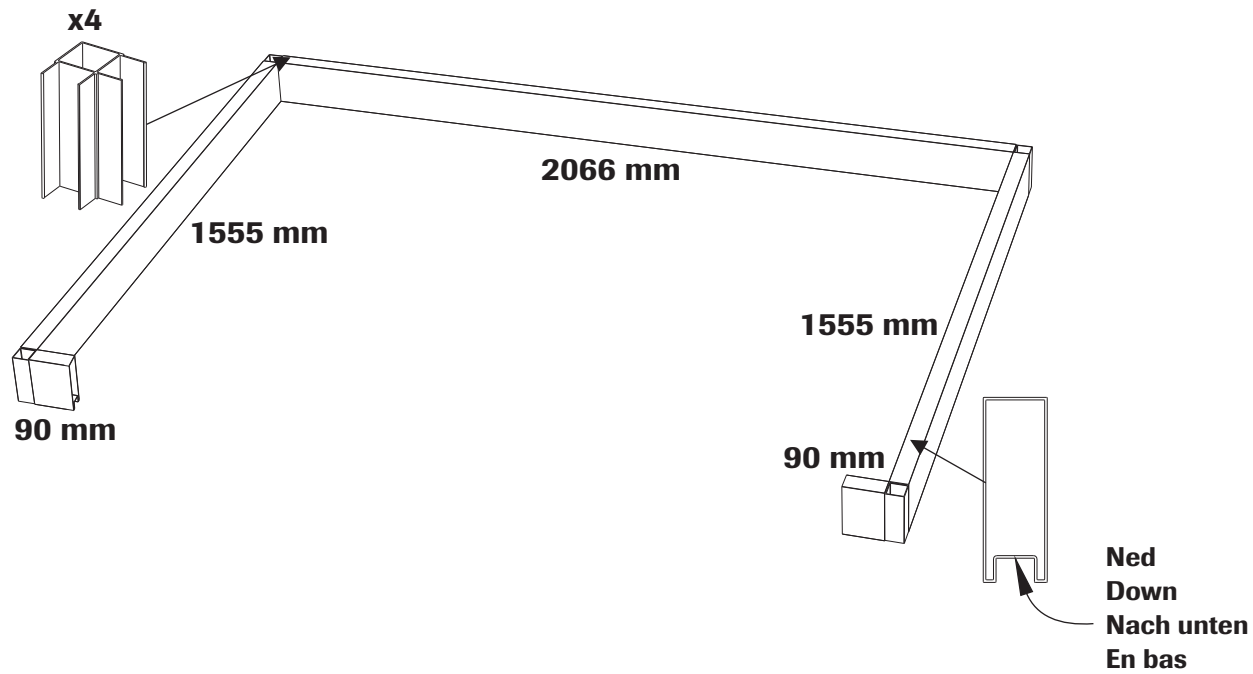
C**D**

Monteringsordning - väggar
 Assembly order - walls

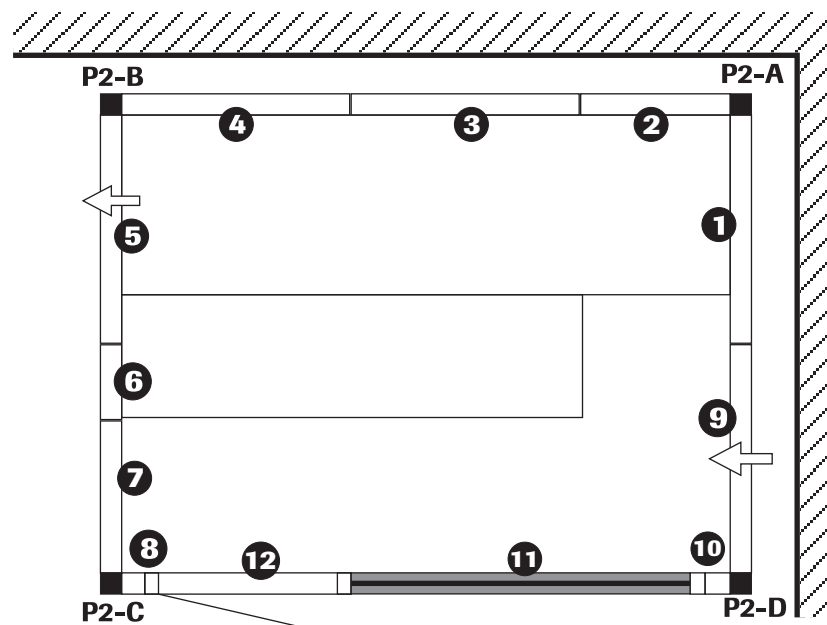
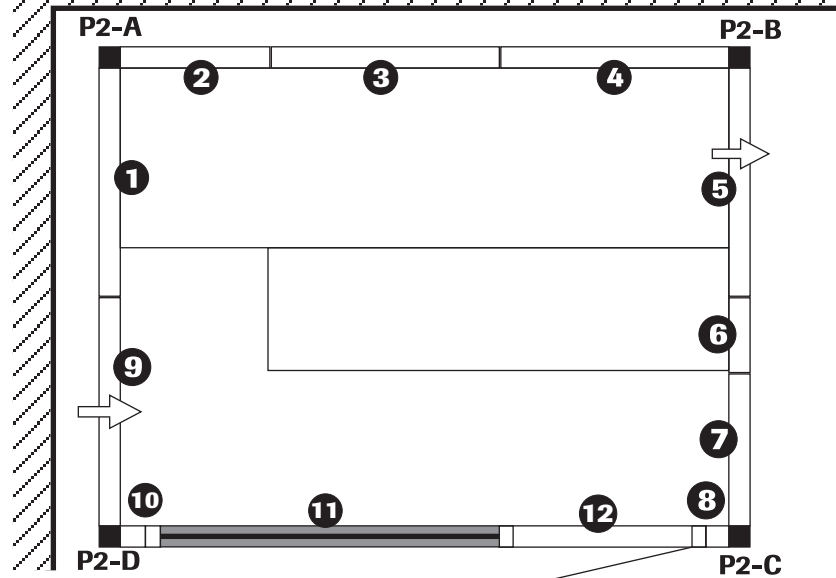

Väggyttermått
 Wall outer dimensions

| | |
|--------------------|---------|
| 1 3 4 | 762 mm |
| 5 9 | |
| 2 7 | 506 mm |
| 6 | 250 mm |
| 8 10 | 77 mm |
| 11 (Glas/glass) | 1194 mm |
| 12 (Dörr/door) | 690 mm |

E

Placering av skarvprofil.
Montering - se monteringsanvisning av rummet.

Location of the joint profile
Assembly - see installation instructions of the room.

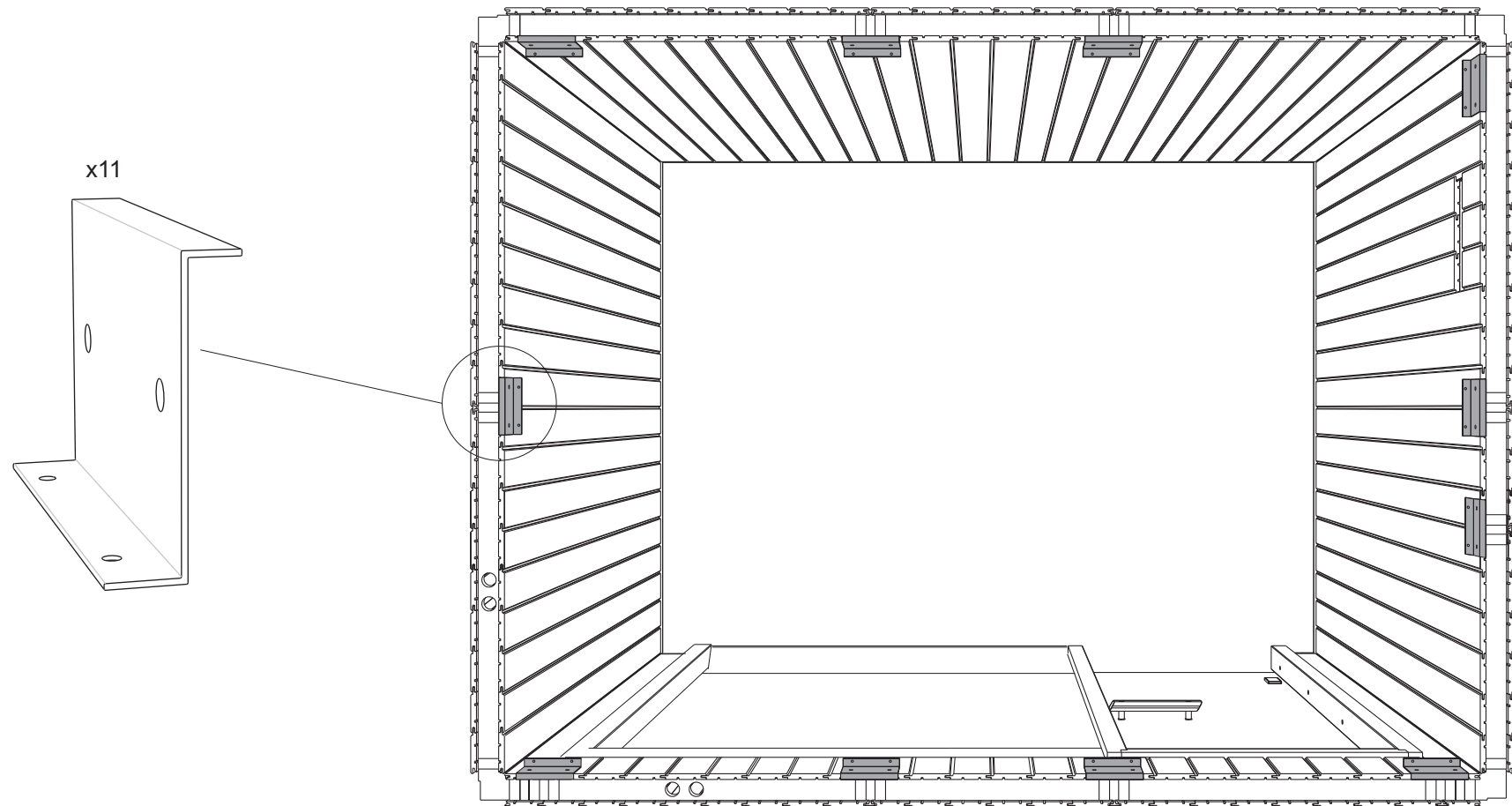

F Layouts 2217 PLUS GF

G = Glass

Standard

Layout 1

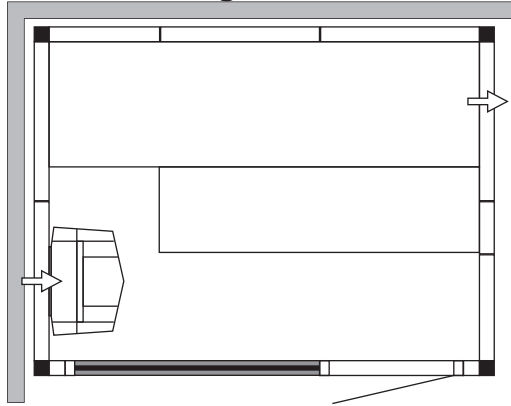

Layout 2

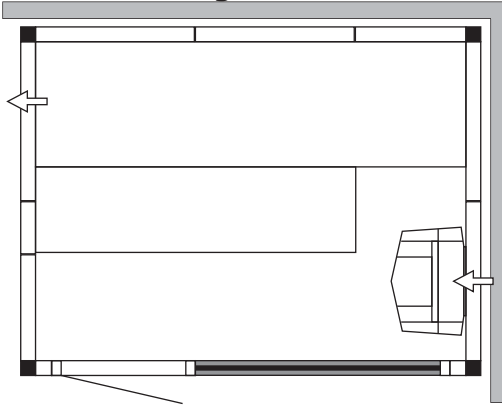

Standard with optional glass section

Layout 3

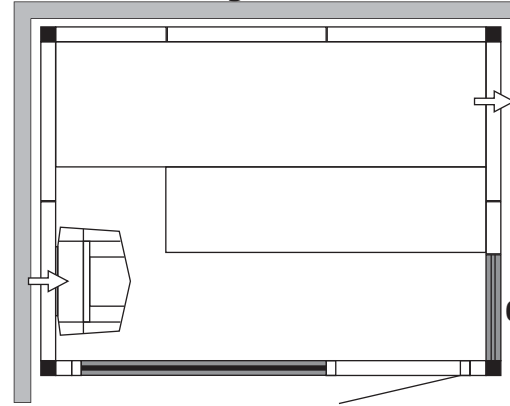

Layout 4

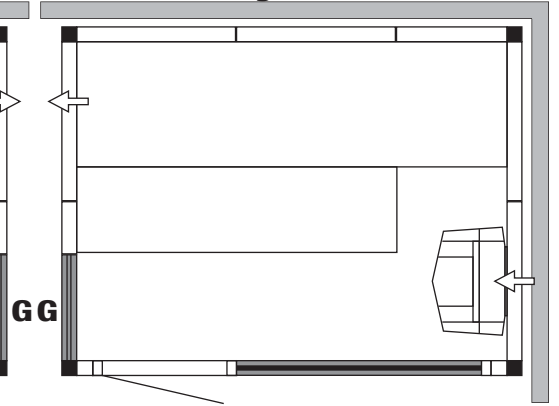

TYLÖ SAUNA E2219 PLUS GF

1202

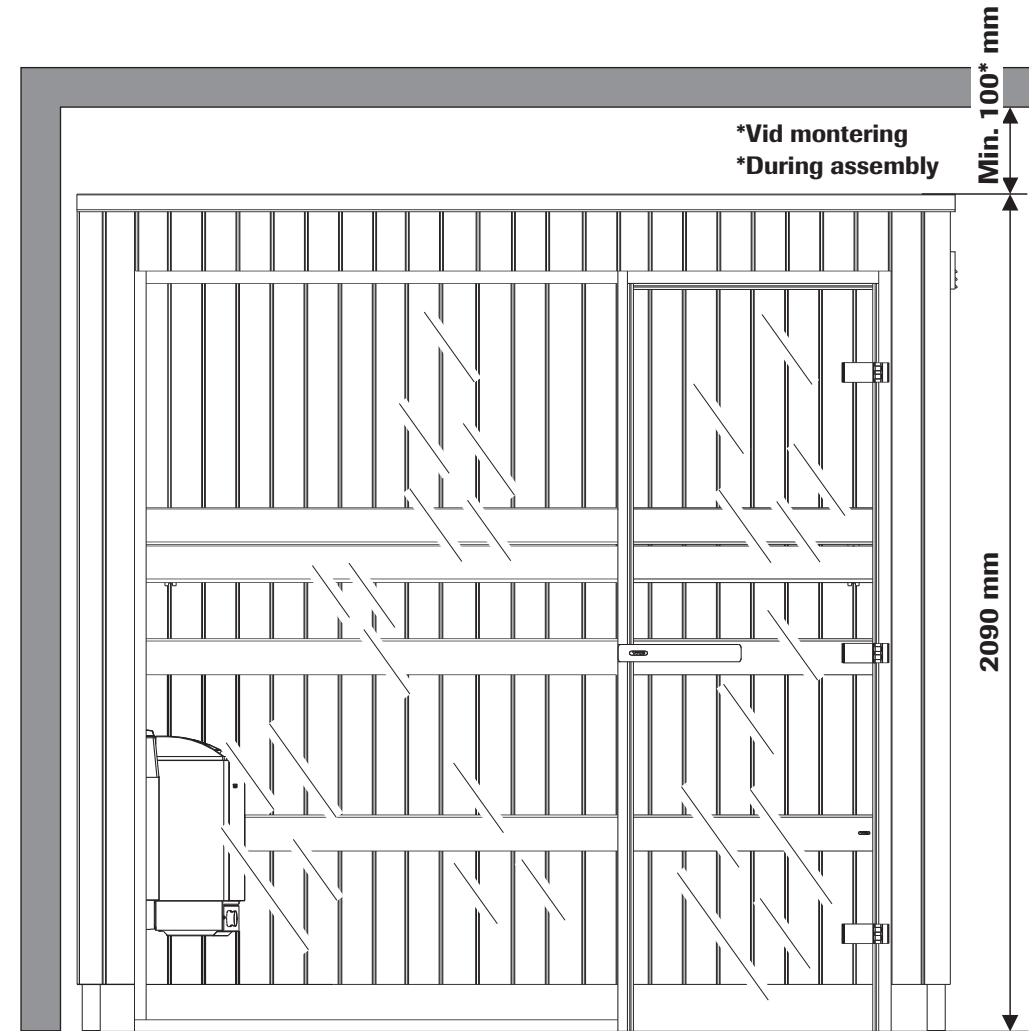
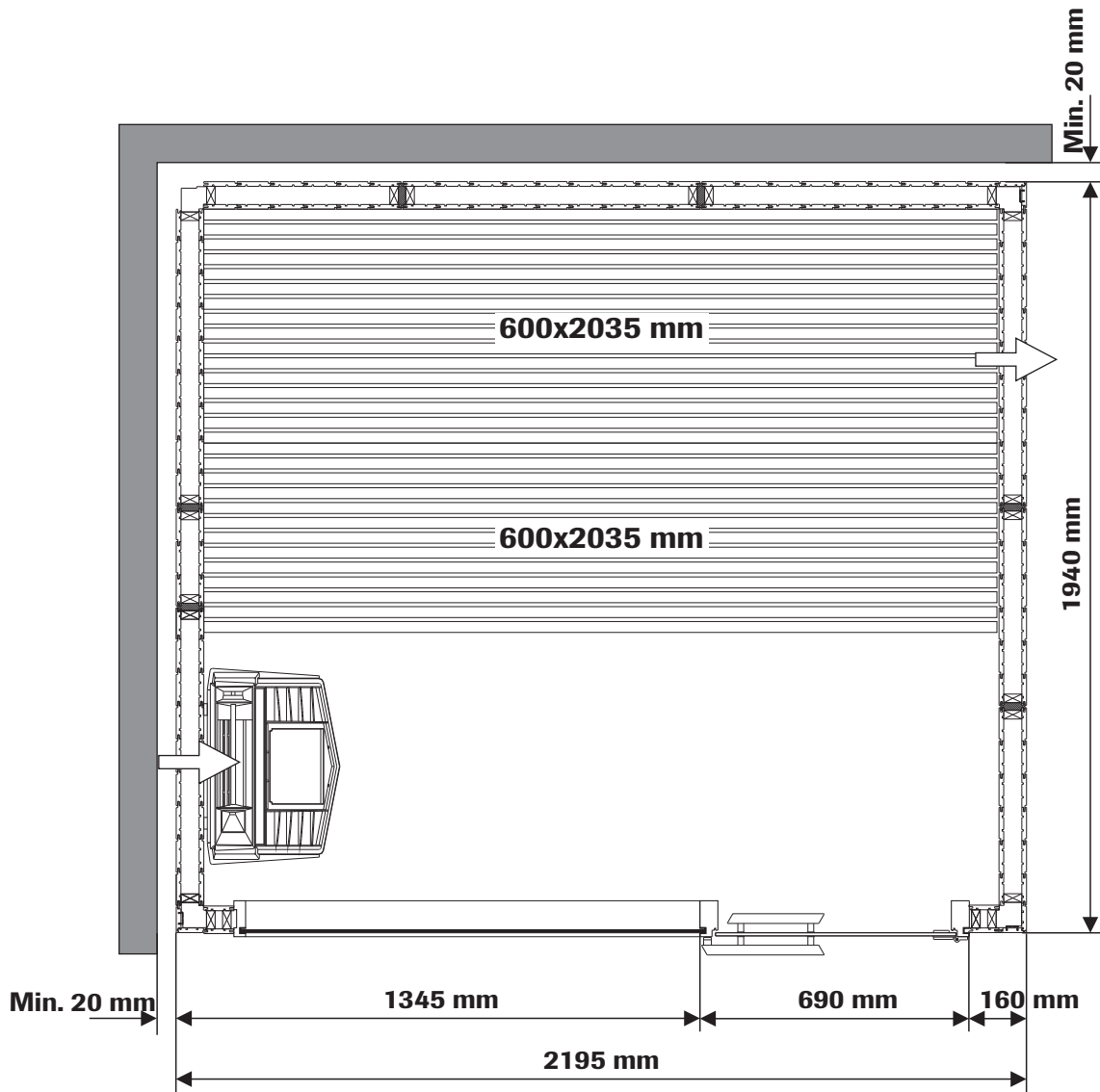

Art.nr 2900 4356

TYLÖ[®]
for the senses

A1

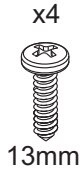
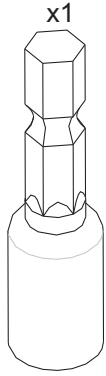

13mm

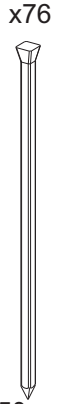

50mm

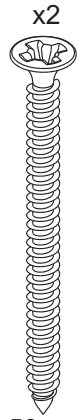

50mm

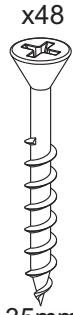

35mm



32mm

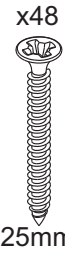

25mm

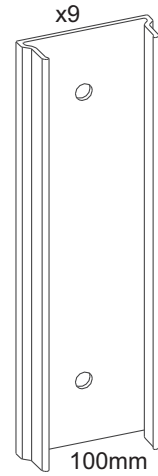
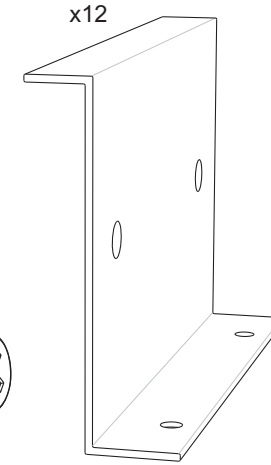
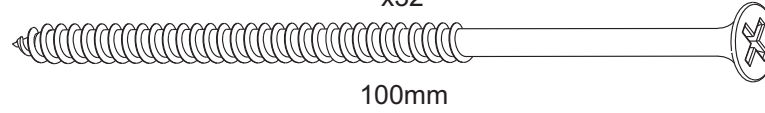
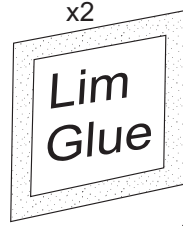

100mm

A2



6.5mm



16mm

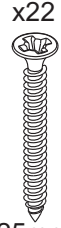

25mm

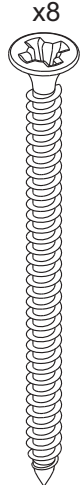

60mm

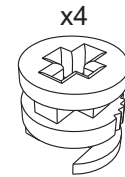

x4



x8

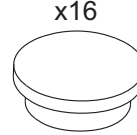

x16



10x5.3x1

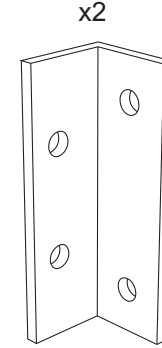

x2

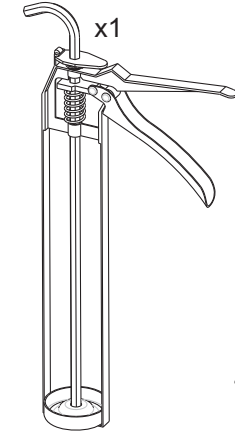

x1



x1



B

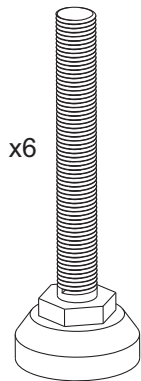
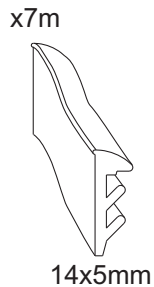
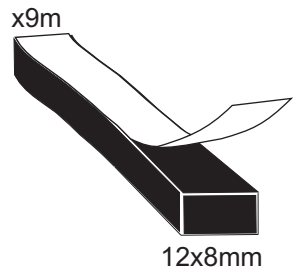

P1

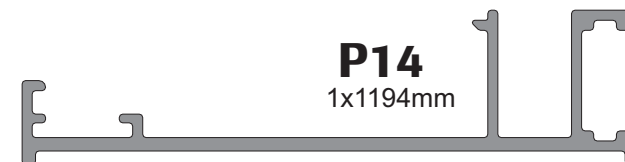
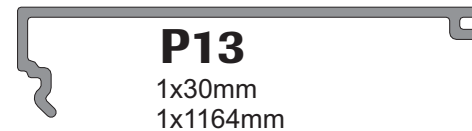
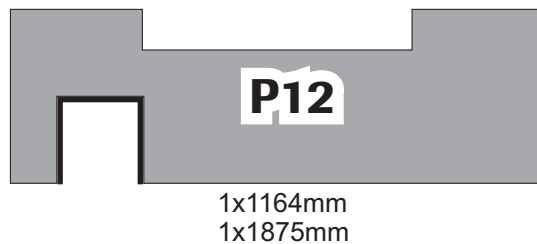
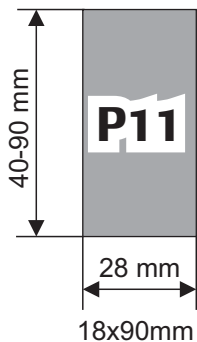
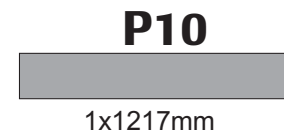
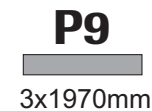
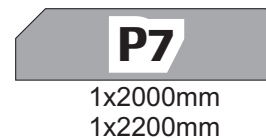
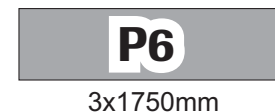
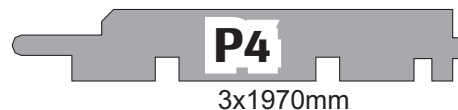
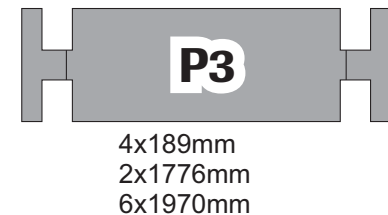
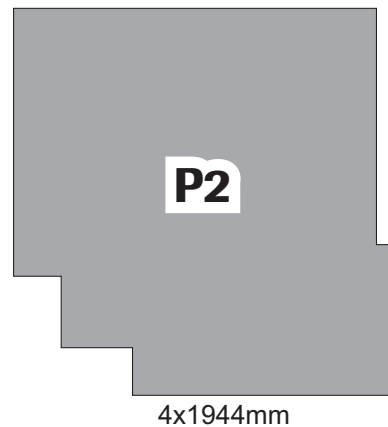
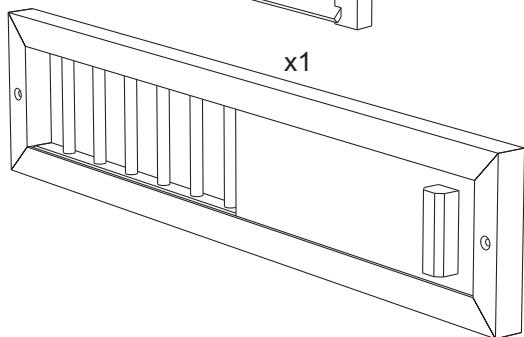
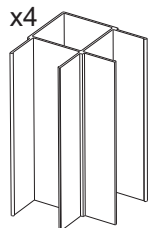
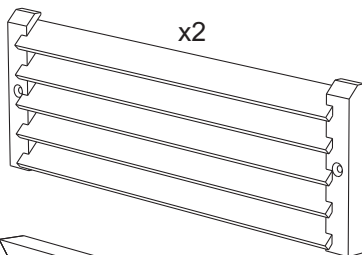

C

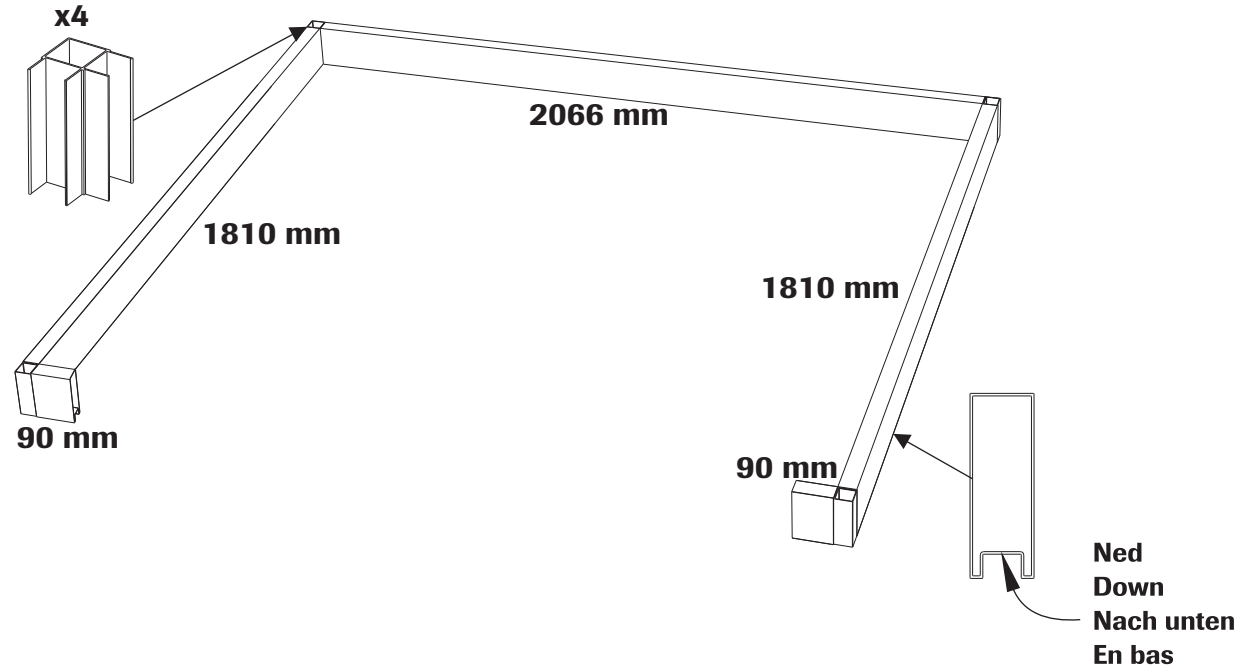

D

Monteringsordning - väggar
Assembly order - walls

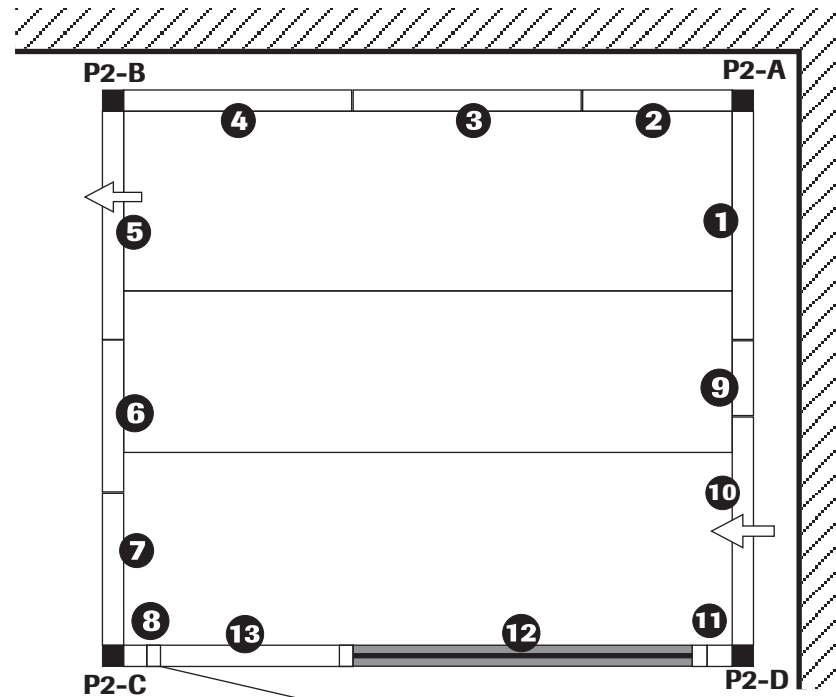
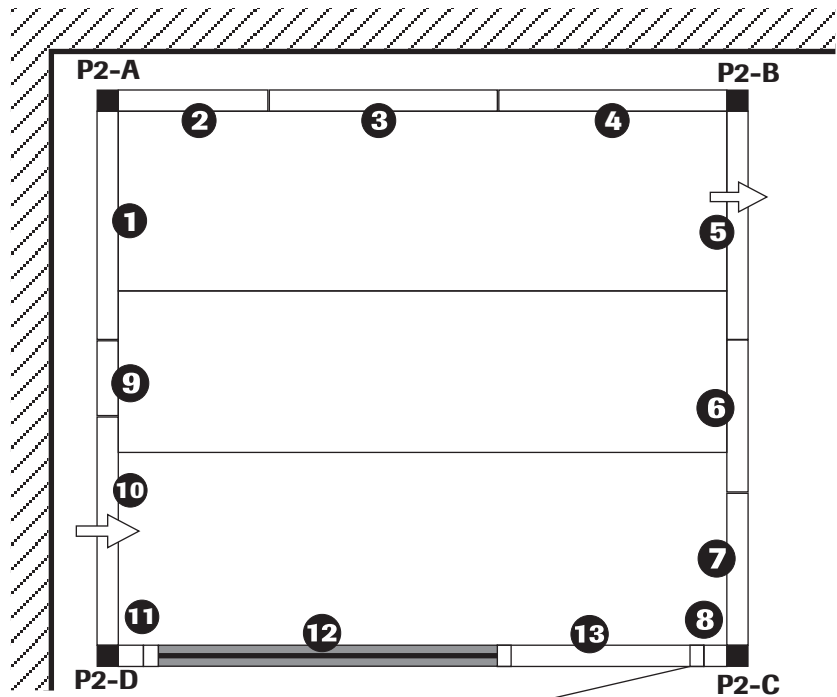

Väggyttermått
Wall outer dimensions

| | |
|--------------------|---------|
| 1 3 4 5 10 | 762 mm |
| 2 6 7 | 506 mm |
| 9 | 250 mm |
| 8 11 | 77 mm |
| 12 (Glas/glass) | 1194 mm |
| 13 (Dörr/door) | 690 mm |

E

Placering av skarvprofil.
Montering - se monteringsanvisning av rummet.

Location of the joint profile
Assembly - see installation instructions of the room.

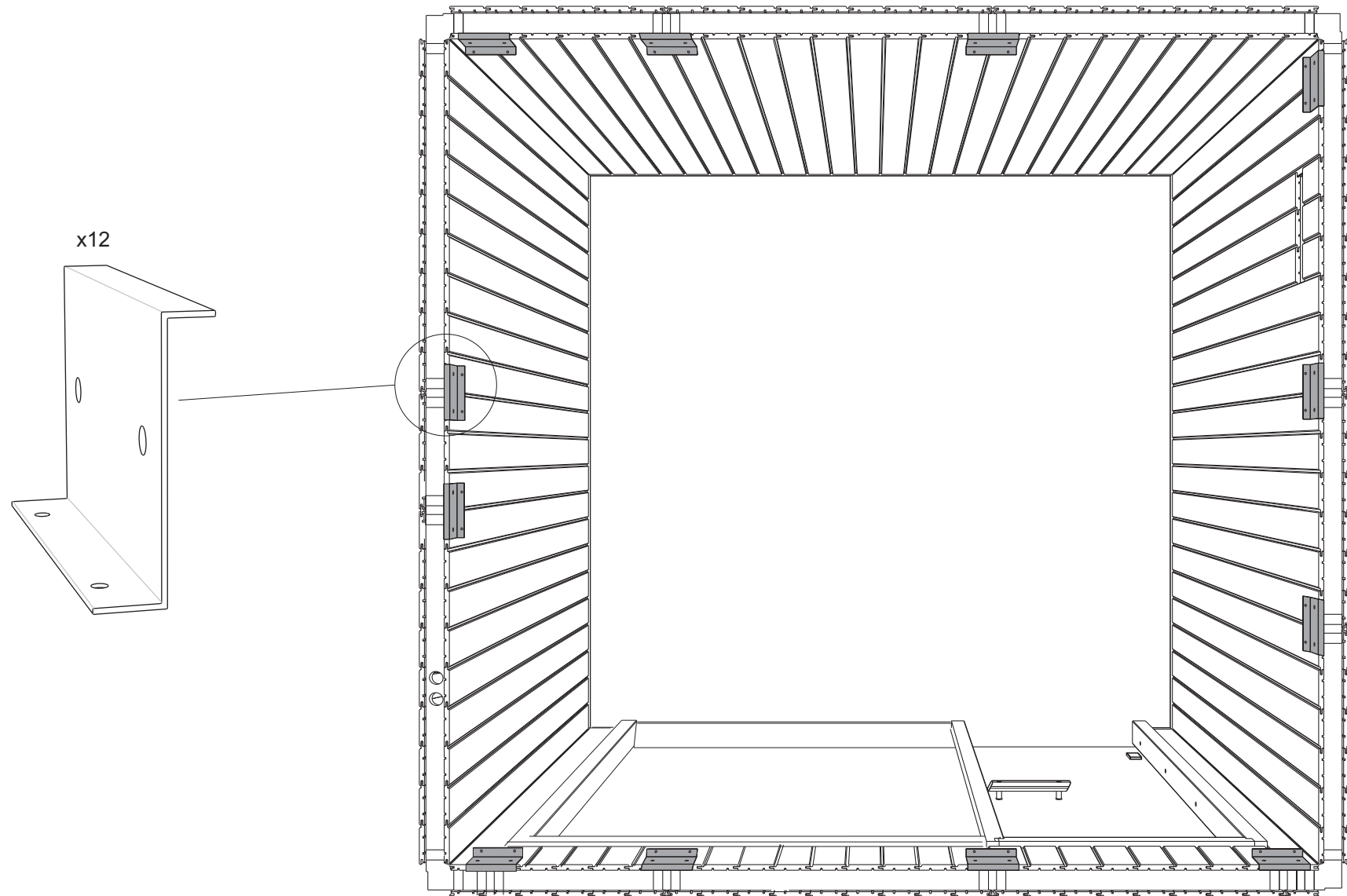

F Layouts 2219 PLUS GF

G = Glass

Standard

Layout 1

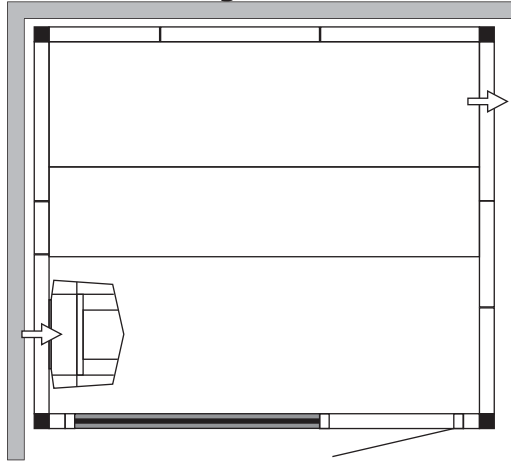

Layout 2

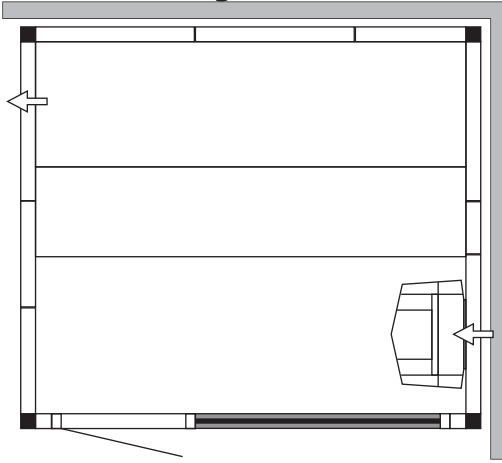

Standard with optional glass section

Layout 3

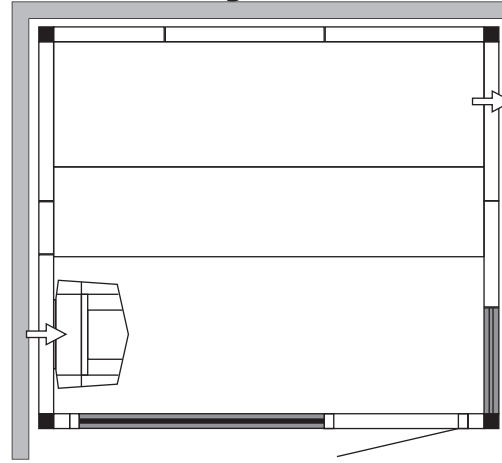

Layout 4

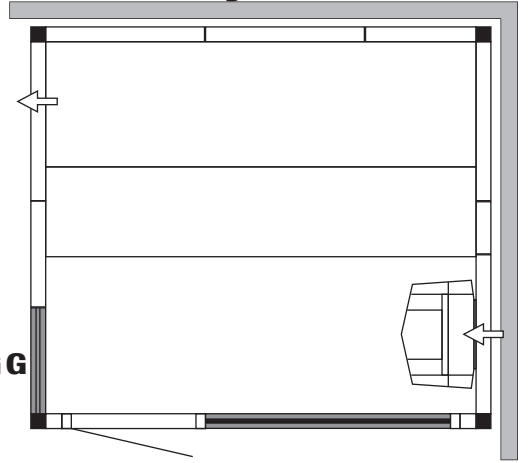

TYLÖ SAUNA E2222 PLUS GF

1202

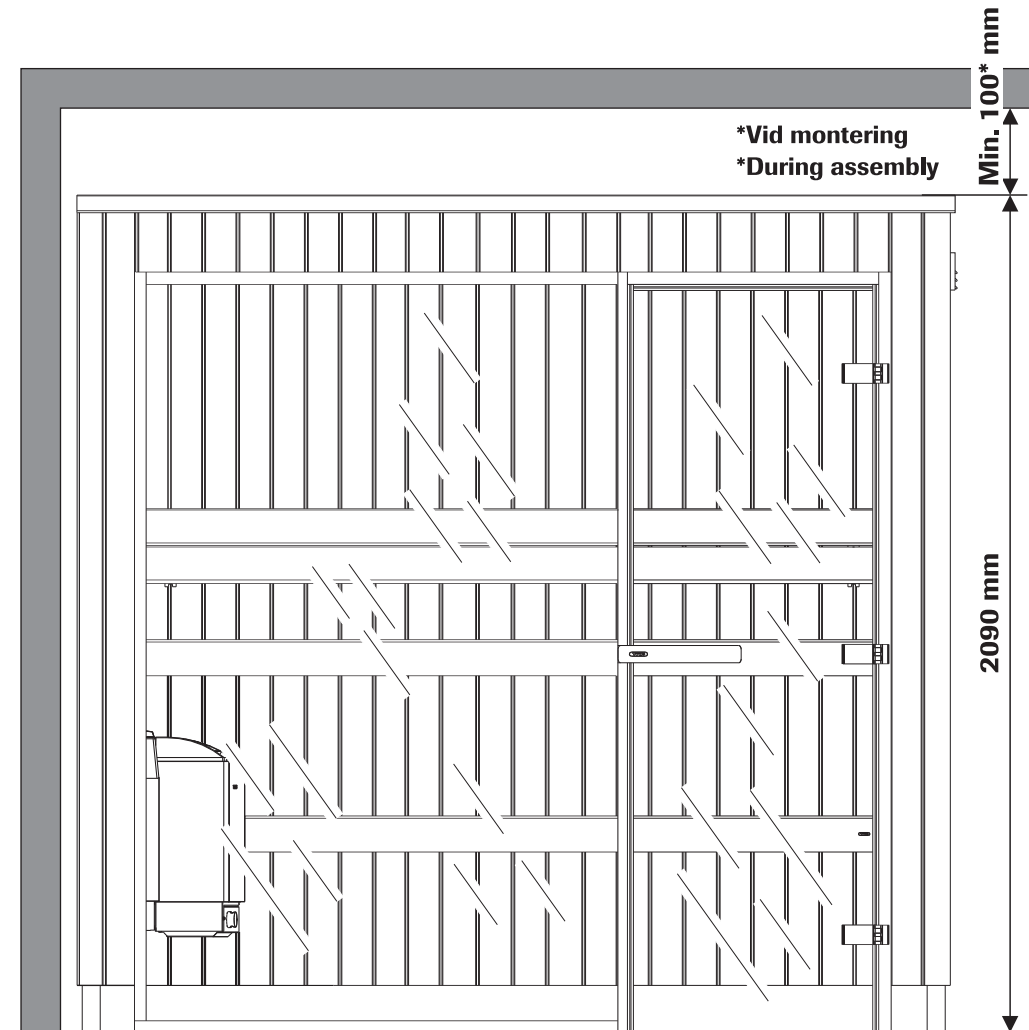
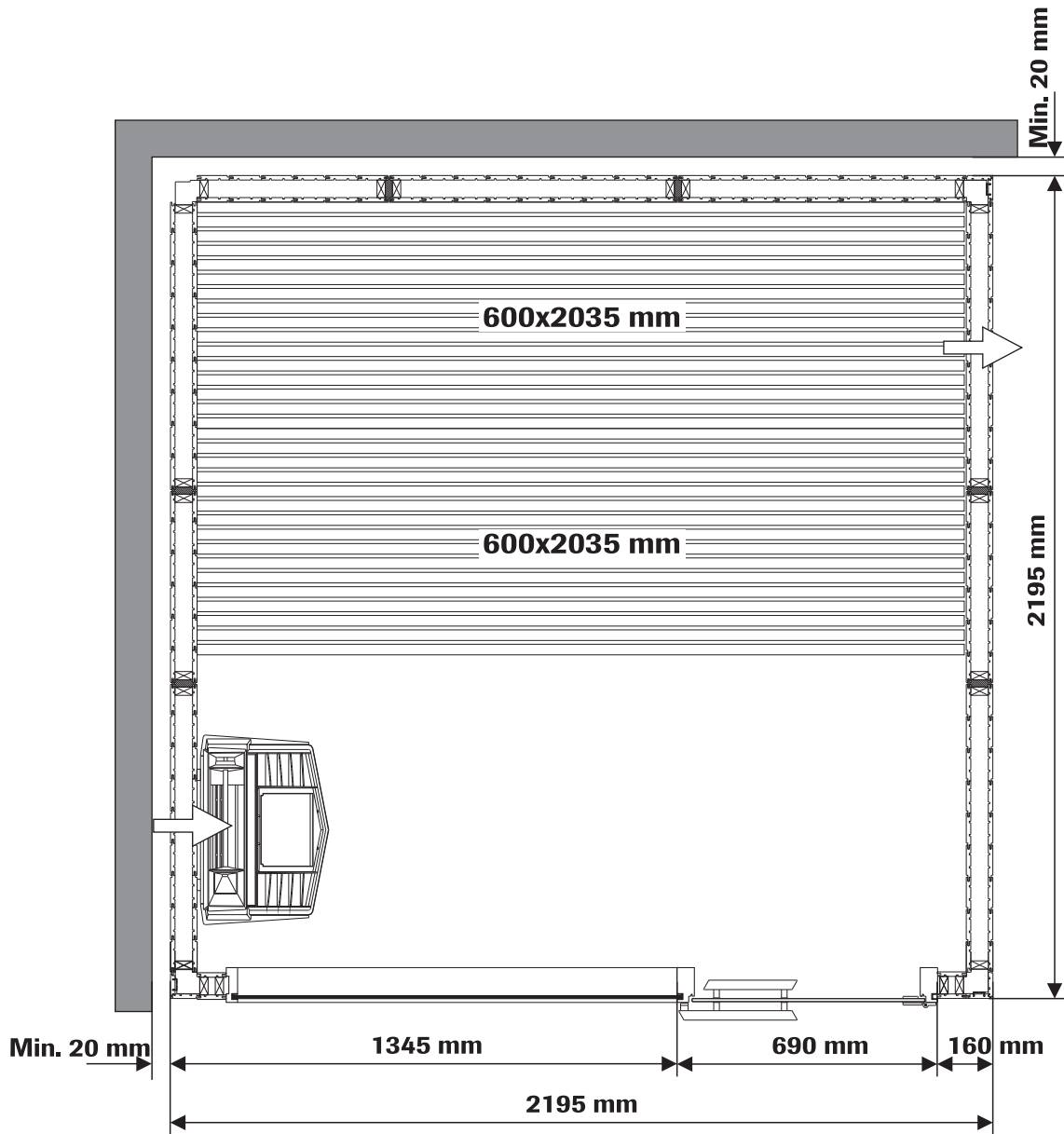

Art.nr 2900 4366

TYLÖ[®]
for the senses

A1

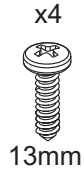
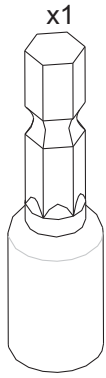

13mm

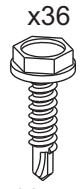

16mm

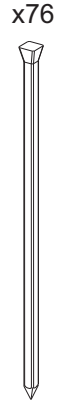

50mm

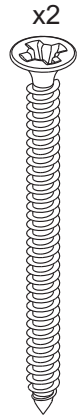

50mm

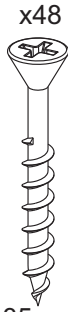

35mm



32mm

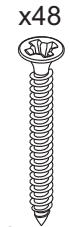

25mm



Lim
Glue



Ø 2



Ø 3.5



Ø 5.5



x32

100mm

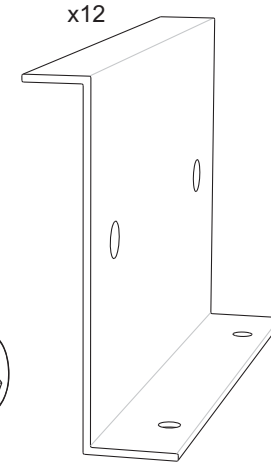

x12

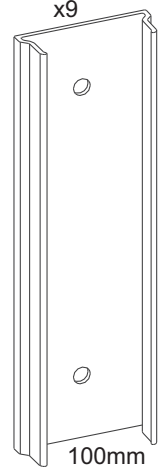

x9

100mm

A2



6.5mm

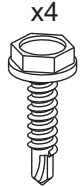

16mm

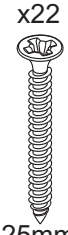

25mm

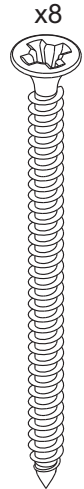

60mm



x4

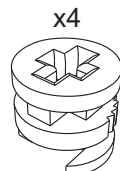

x4



x8

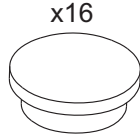

x16

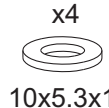

10x5.3x1

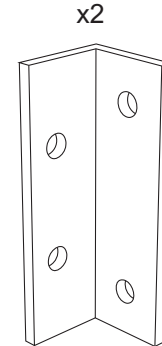

x2

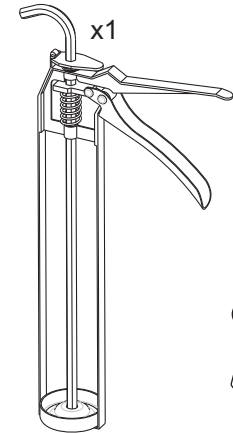

x1



x1



Ø 4.5

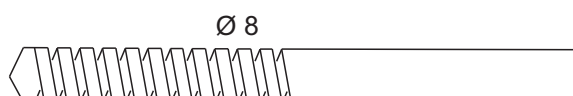

Ø 8

B

x9m

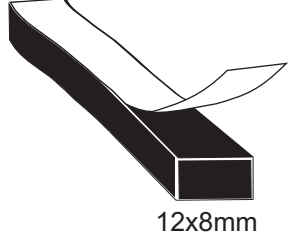

12x8mm

x7m

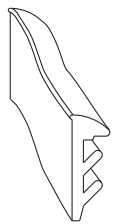

14x5mm

x6

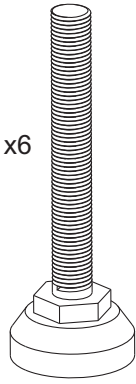
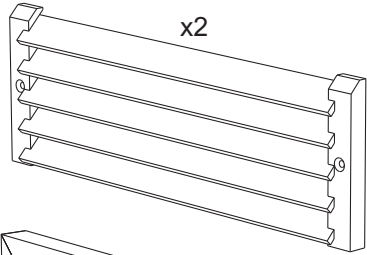
**P1**2x90mm
3x2066mm

x2

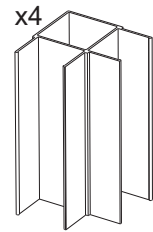

x4

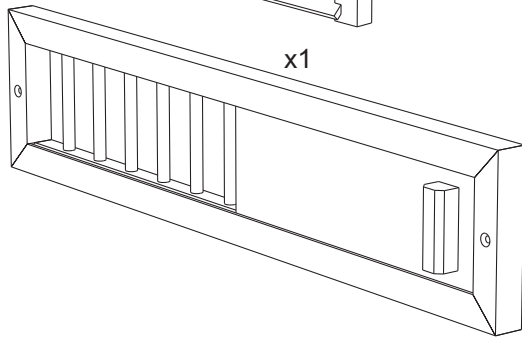

x1

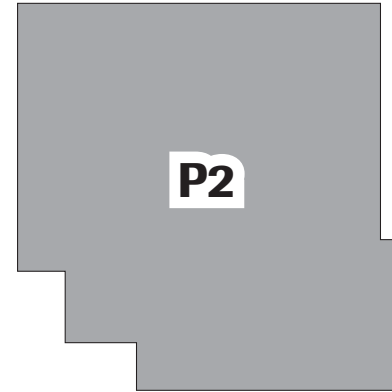
**P2**

4x1944mm

**P6**

3x1750mm

**P7**

2x2200mm

**P8**

4x2100mm

P9

3x1970mm

**P3**4x189mm
4x1010mm
6x1970mm**P4**

3x1970mm

**P5**

3x1970mm

**P10**

1x1217mm

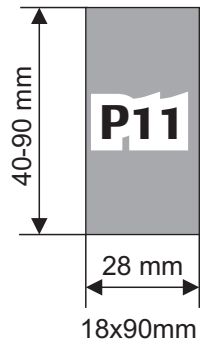
**P11**

18x90mm

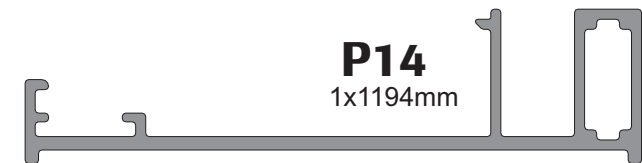
**P12**1x1164mm
1x1875mm**P13**1x30mm
1x1164mm**P14**

1x1194mm

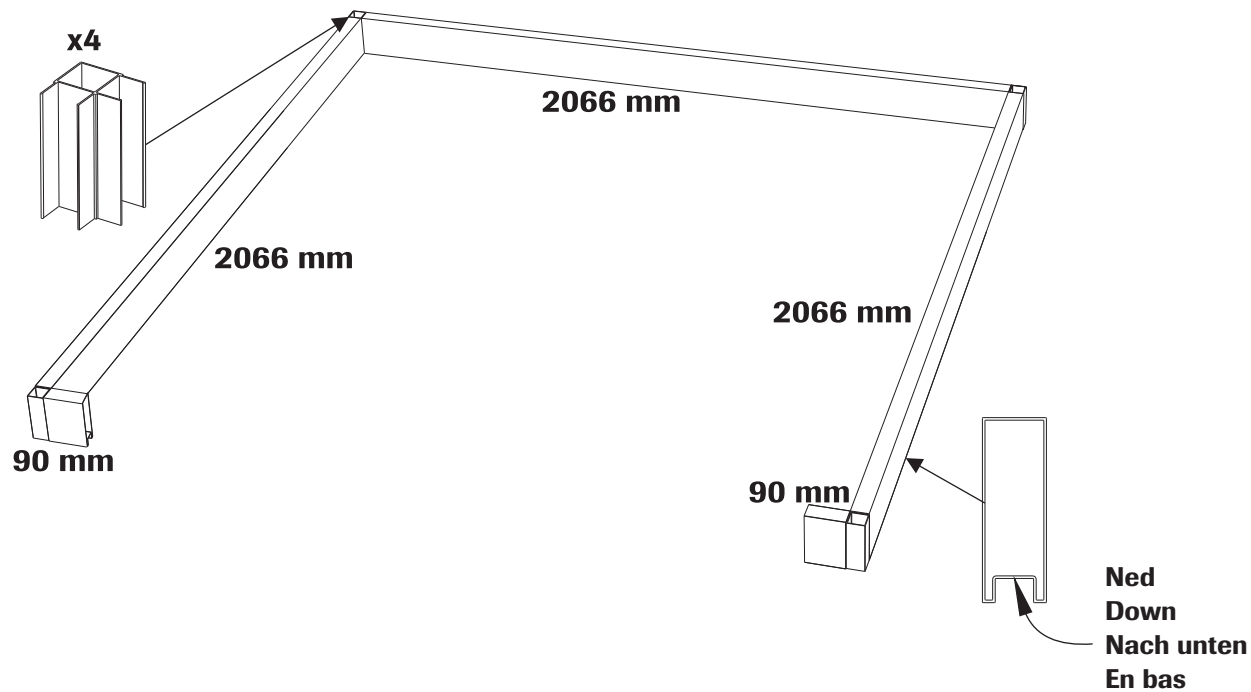
C**D**

Monteringsordning - väggar
Assembly order - walls

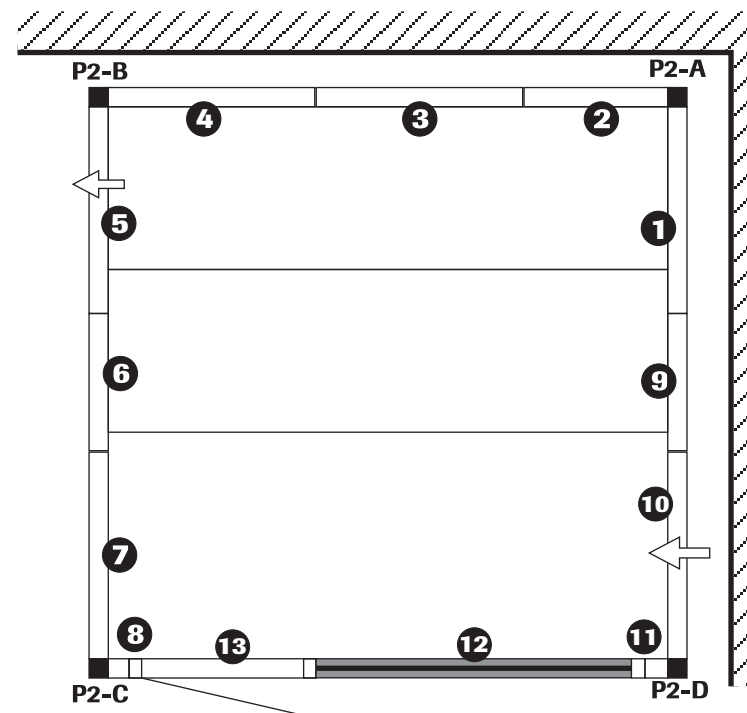
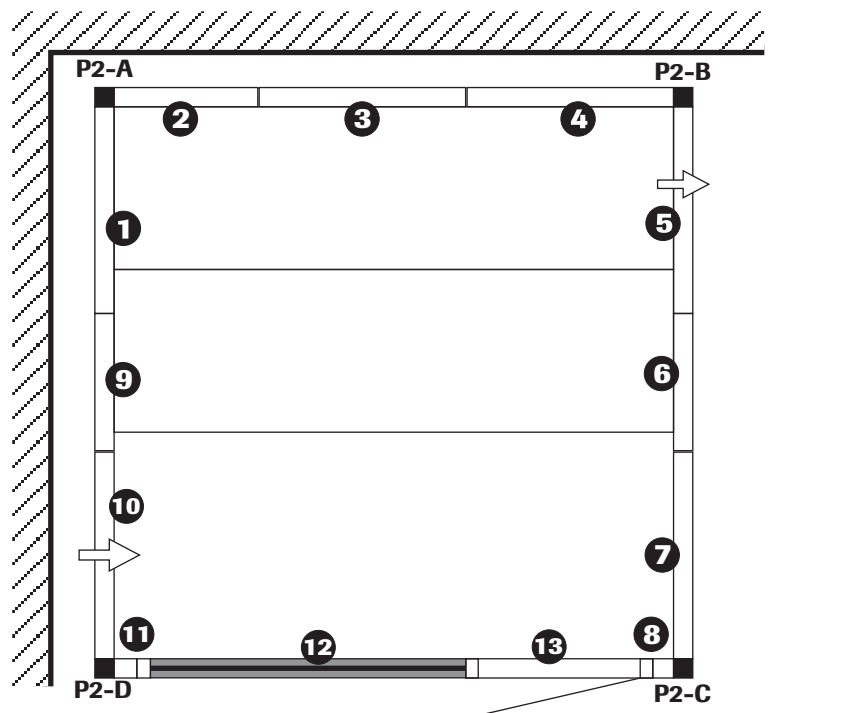

Väggyttermått
Wall outer dimensions

1 3 4
5 7 10

762 mm

2 6 9

506 mm

8 11

77 mm

12
(Glas/glass)

1194 mm

13
(Dörr/door)

690 mm

E

Placering av skarvprofil.
Montering - se monteringsanvisning av rummet.

Location of the joint profile
Assembly - see installation instructions of the room.

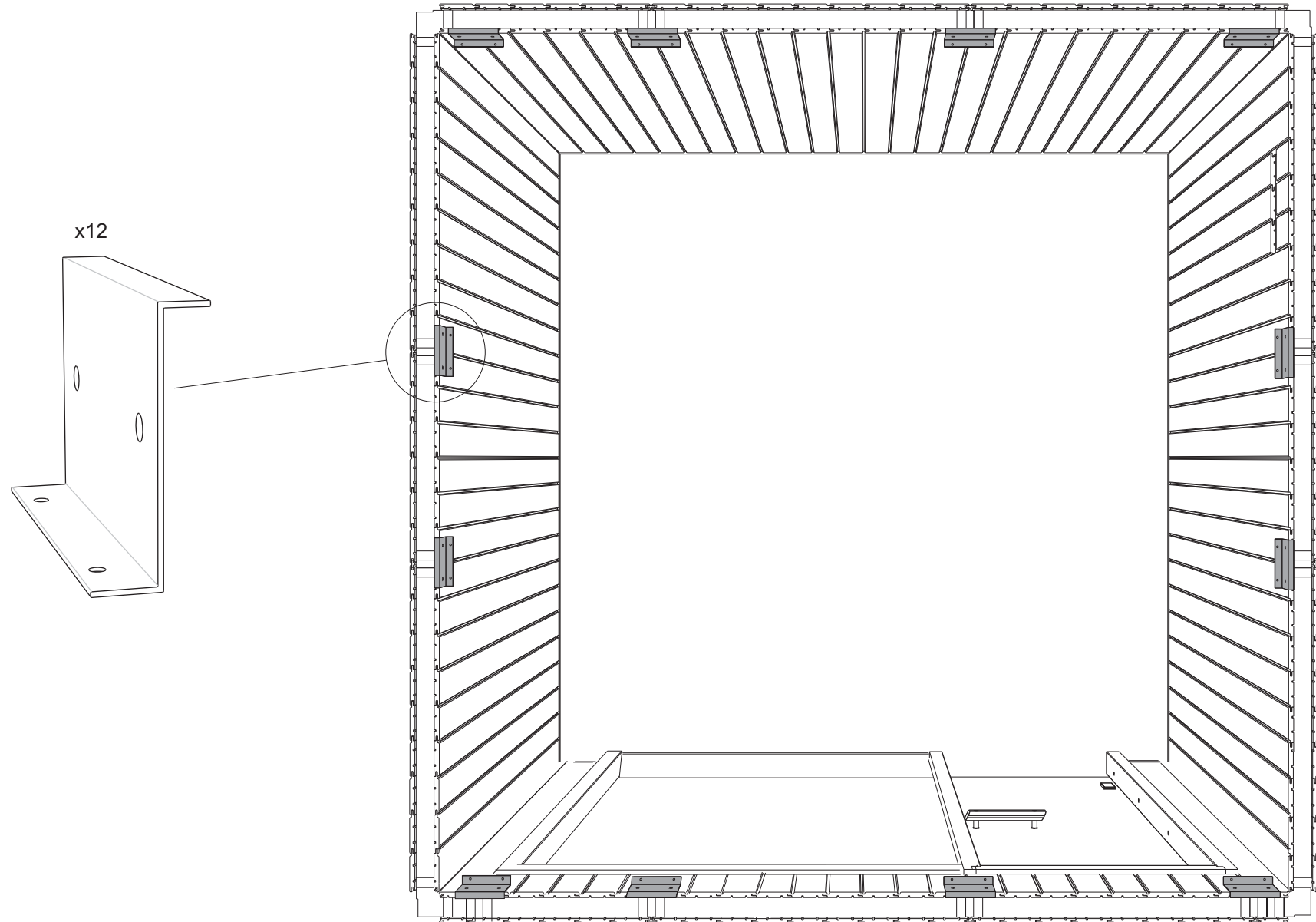

F Layouts 2222 PLUS GF

G = Glass

Standard

Layout 1

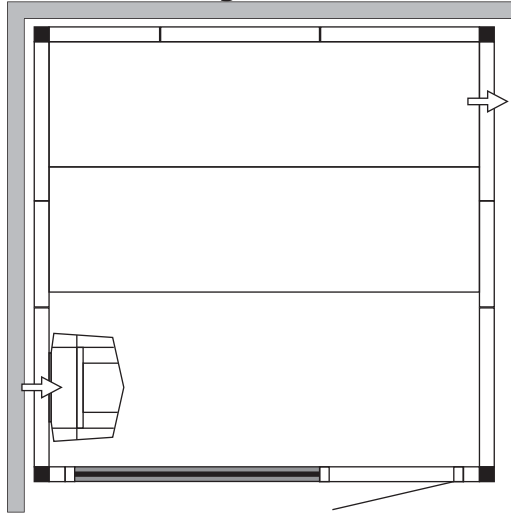

Layout 2

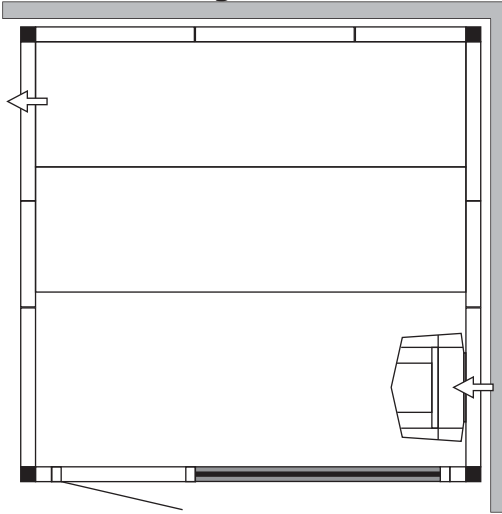

Standard with optional glass section

Layout 3

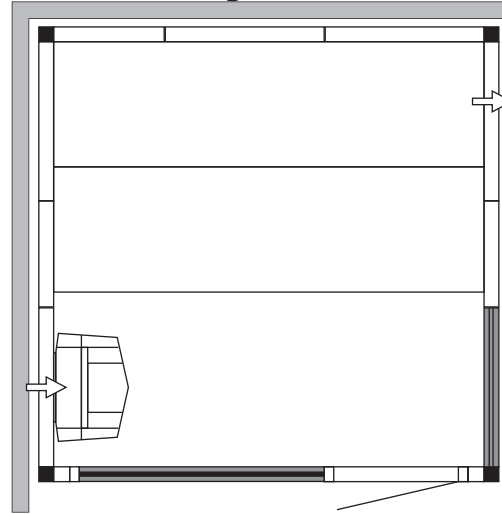

Layout 4

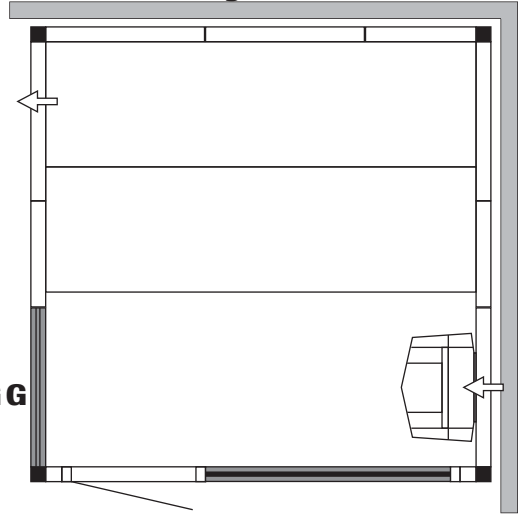

TYLÖ SAUNA E2419 PLUS GF

1202

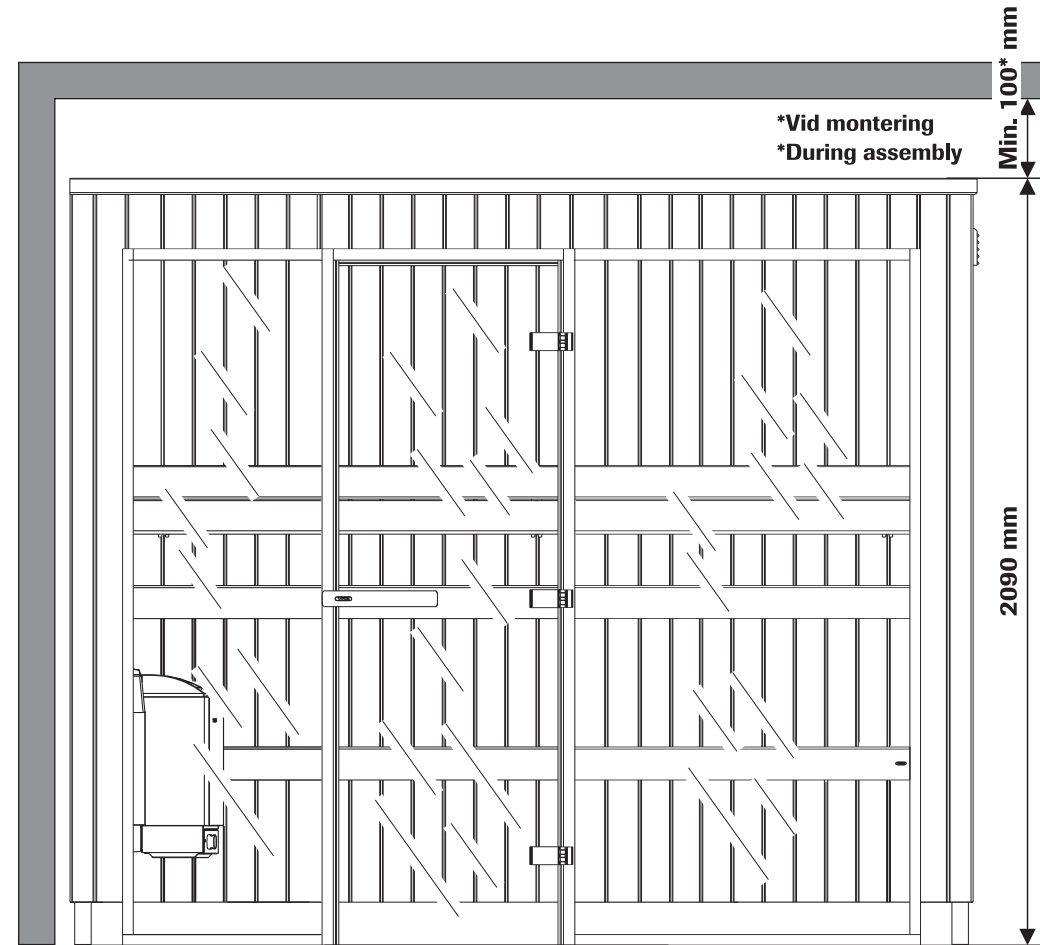
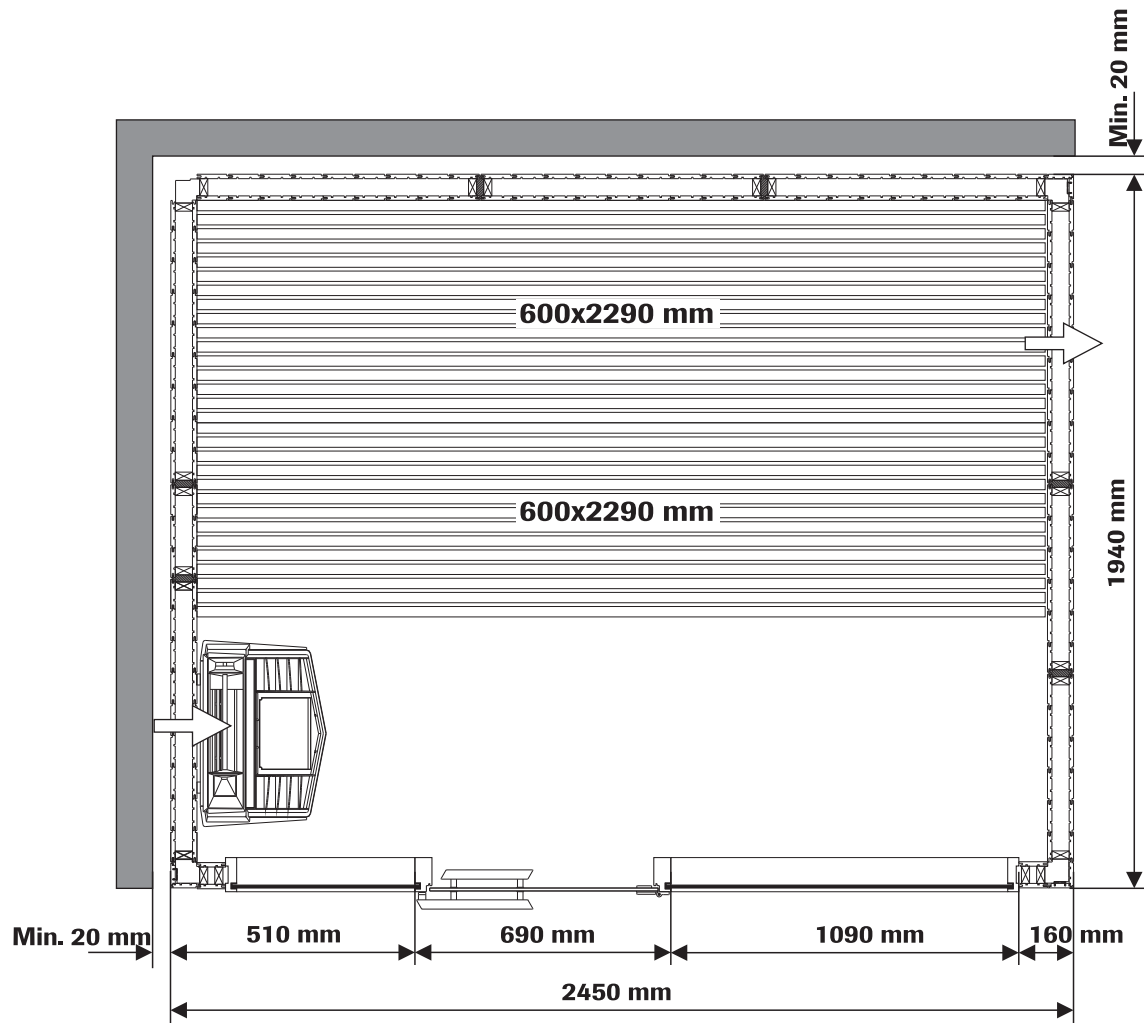

Art.nr 2900 4371

TYLÖ[®]
for the senses

A1

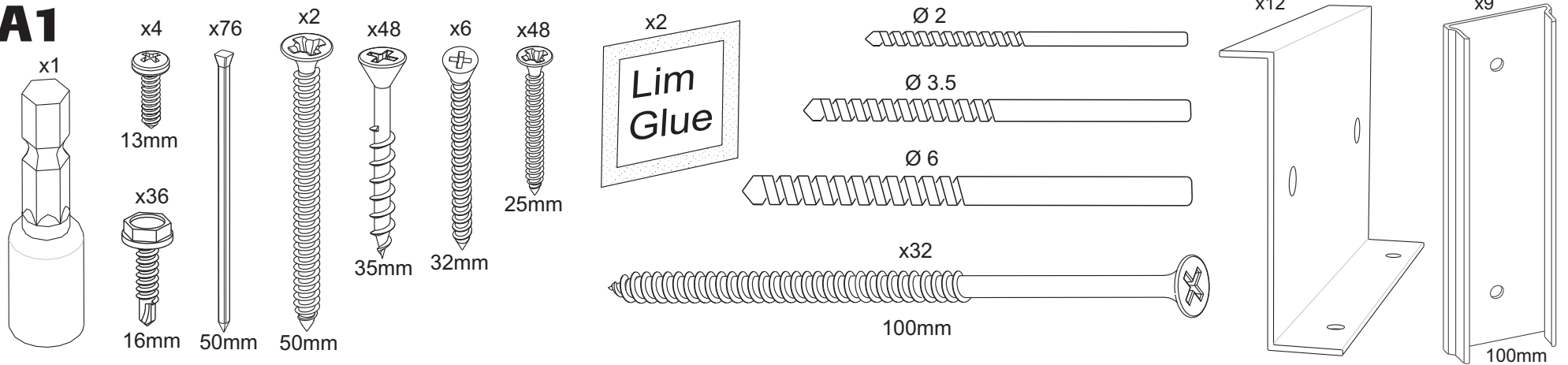

A2

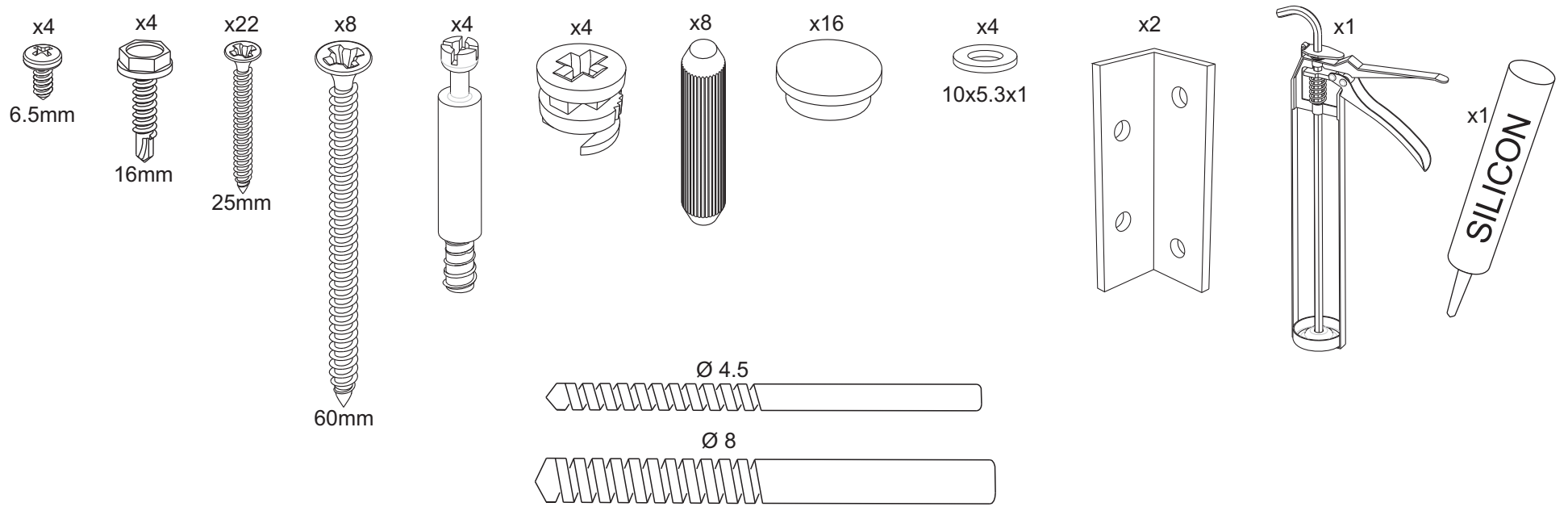

B

x9m

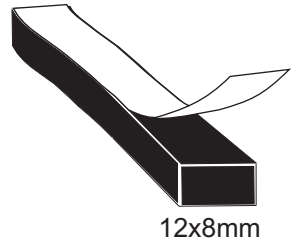

x11m

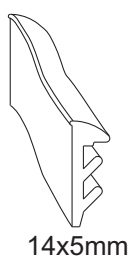

x8

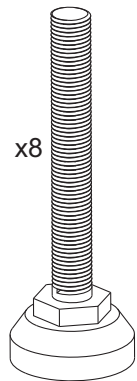
**P1**

2x90mm
1x1023mm
1x1299mm
2x1810mm

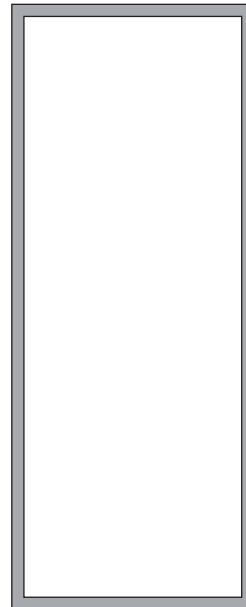
P15

1x150mm

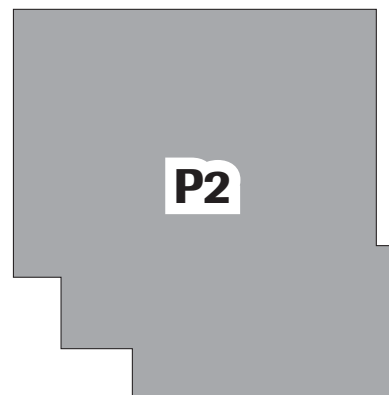
P2

4x1944mm

P6

4x1750mm

P7

1x900mm
2x2000mm

P8

5x2000mm

P9

3x1970mm

P3

4x189mm
2x1776mm
6x1970mm

P4

3x1970mm

P5

3x1970mm

P10

1x1217mm

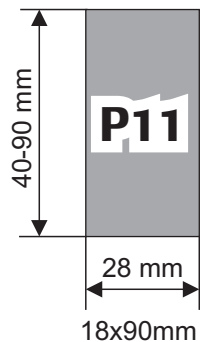
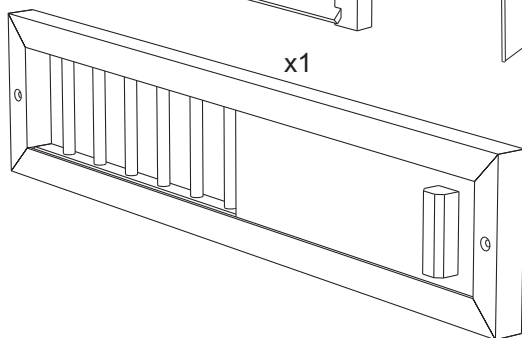
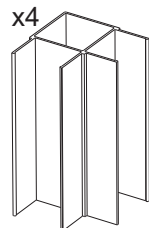
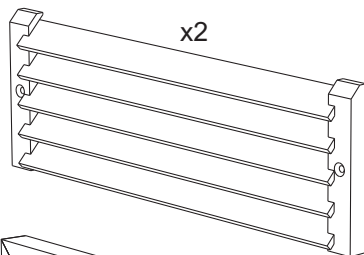
**P11****P12**

1x482mm
1x908mm
2x1875mm

P13

2x30mm
1x482mm
1x908mm

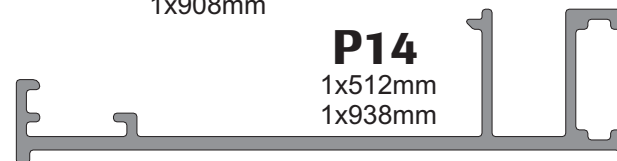
P14

1x512mm
1x938mm

C

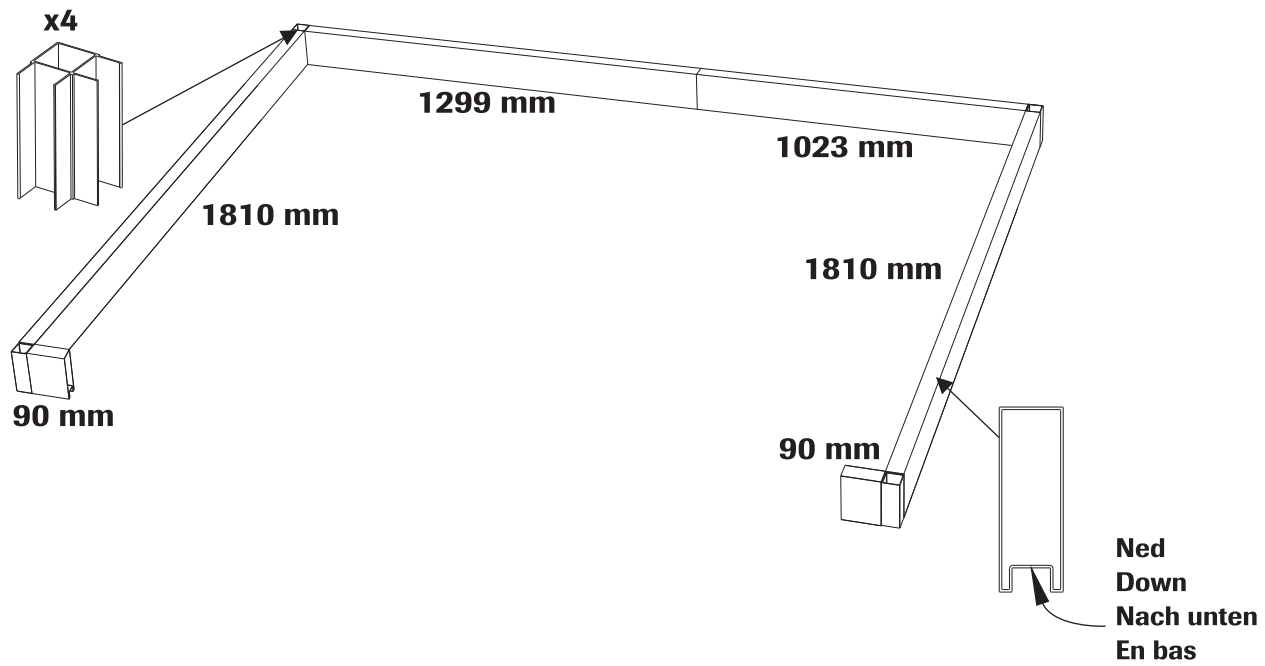
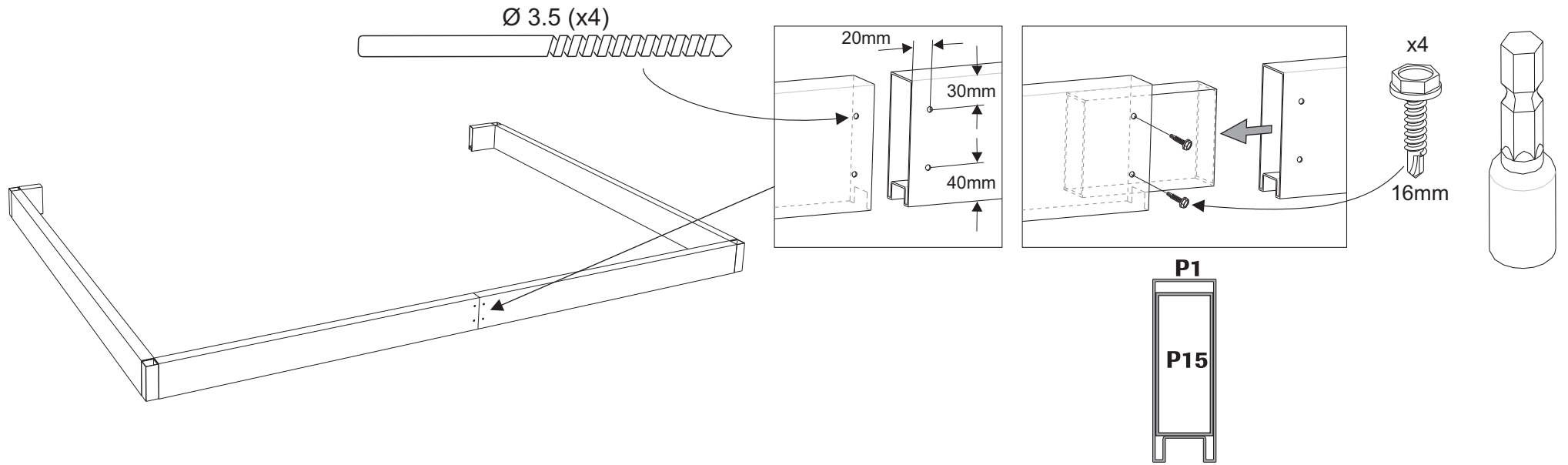

D

Monteringsordning - väggar
 Assembly order - walls

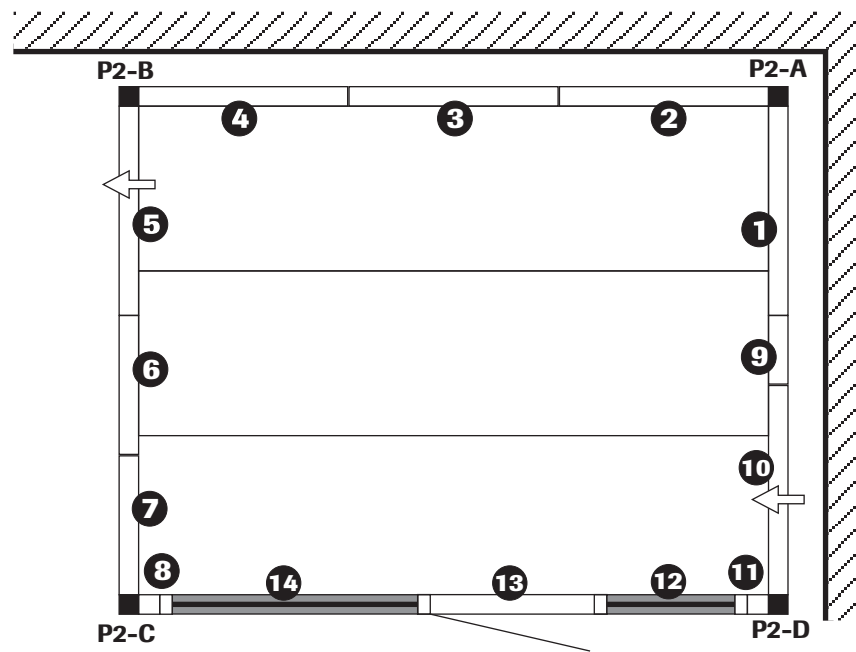
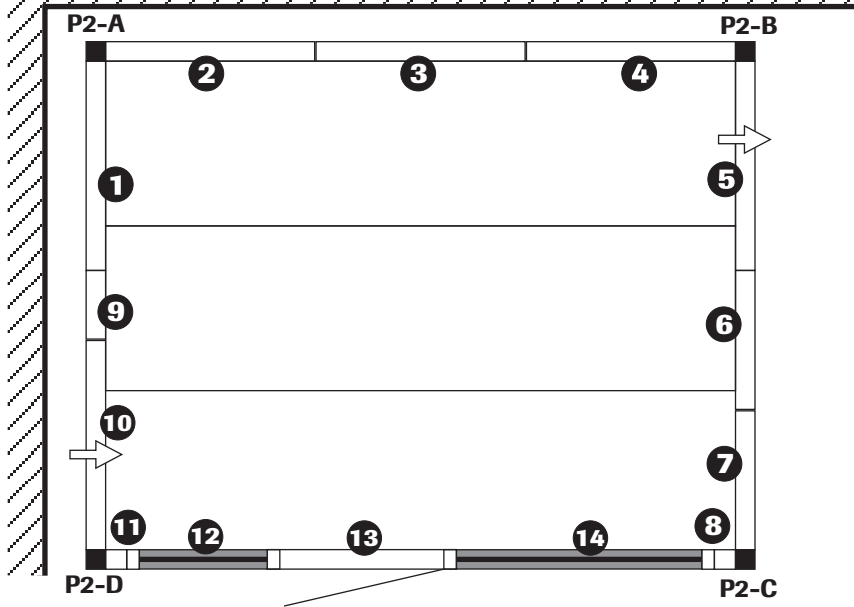

Väggytermått
 Wall outer dimensions

| | |
|---------------------------|--------|
| 1 2 3 | 762 mm |
| 4 5 10 | |
| 6 7 | 506 mm |
| 9 | 250 mm |
| 8 11 | 77 mm |
| 12 (Glas/glass) | 512 mm |
| 14 (Glas/glass) | 938 mm |
| 13 (Dörr/door) | 690 mm |

E

Placering av skarvprofil.
Montering - se monteringsanvisning av rummet.

Location of the joint profile
Assembly - see installation instructions of the room.

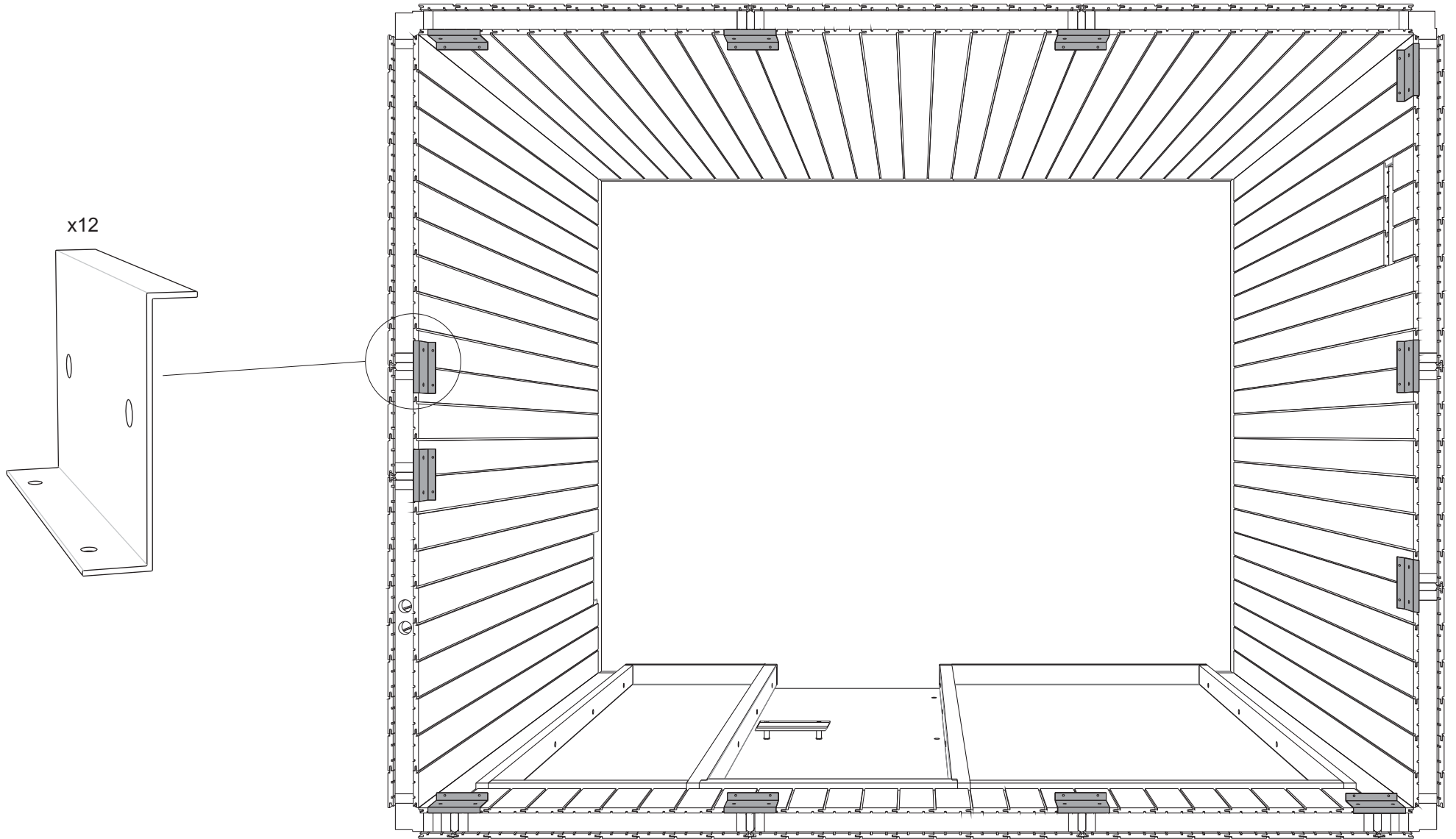

F Layouts 2419 PLUS GF

G = Glass

Standard

Layout 1

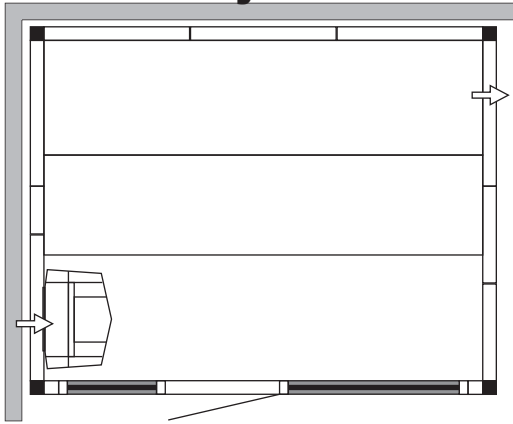

Layout 2

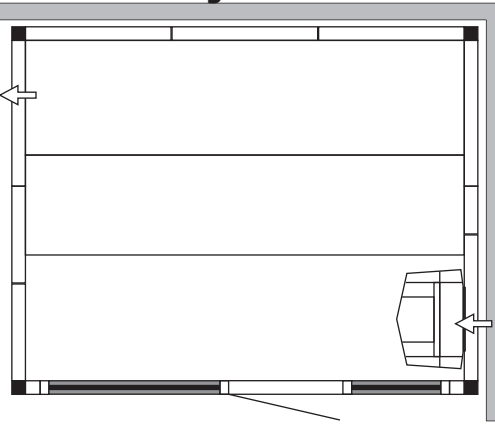

Standard with optional glass section

Layout 3

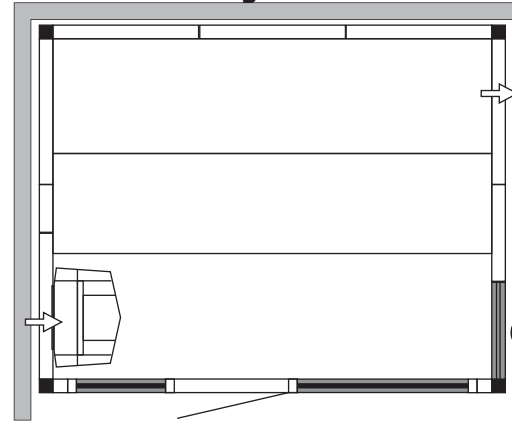

Layout 4

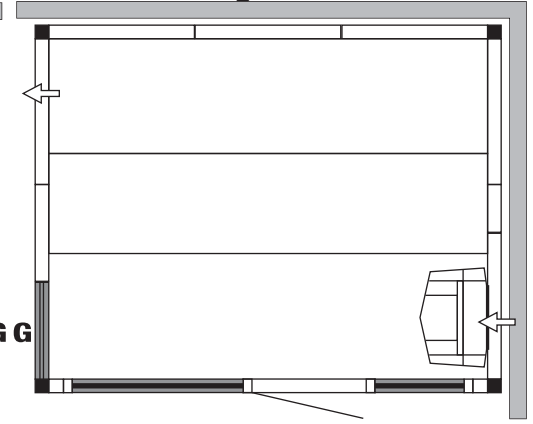

TYLÖ SAUNA E2422 PLUS GF

1202

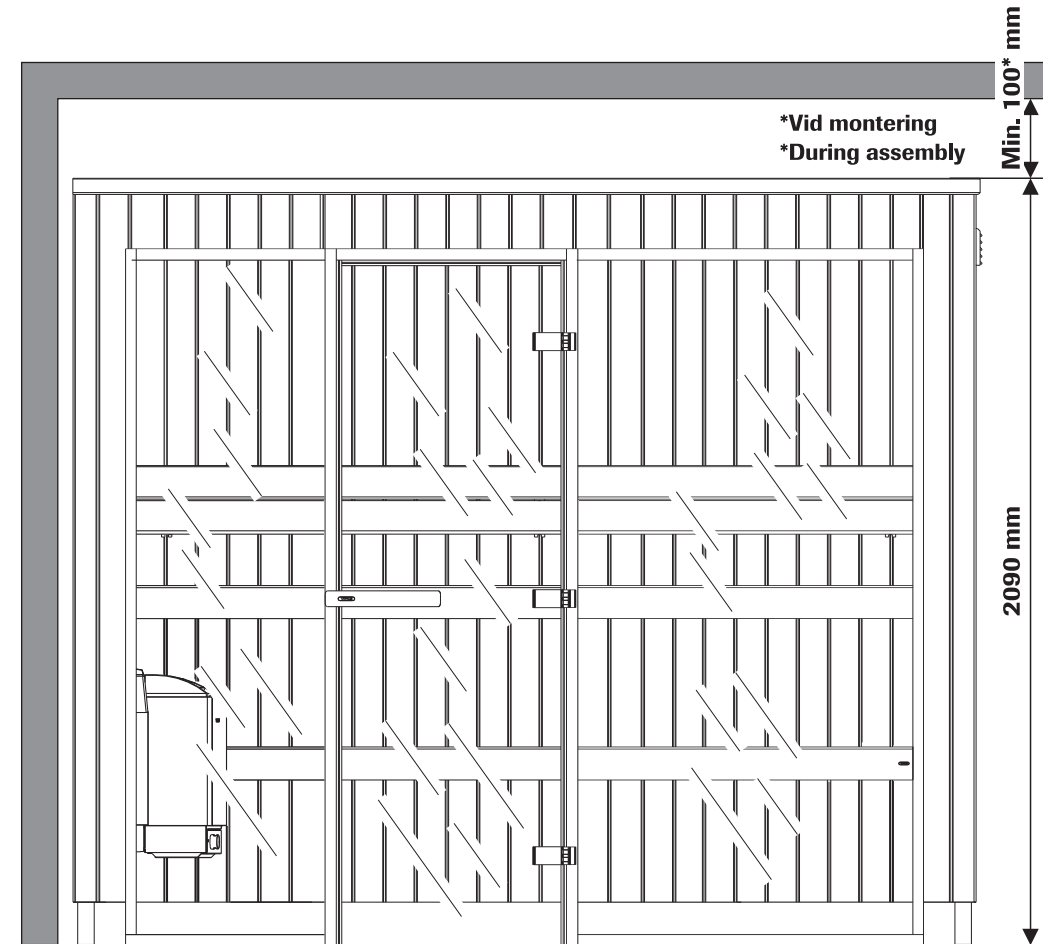
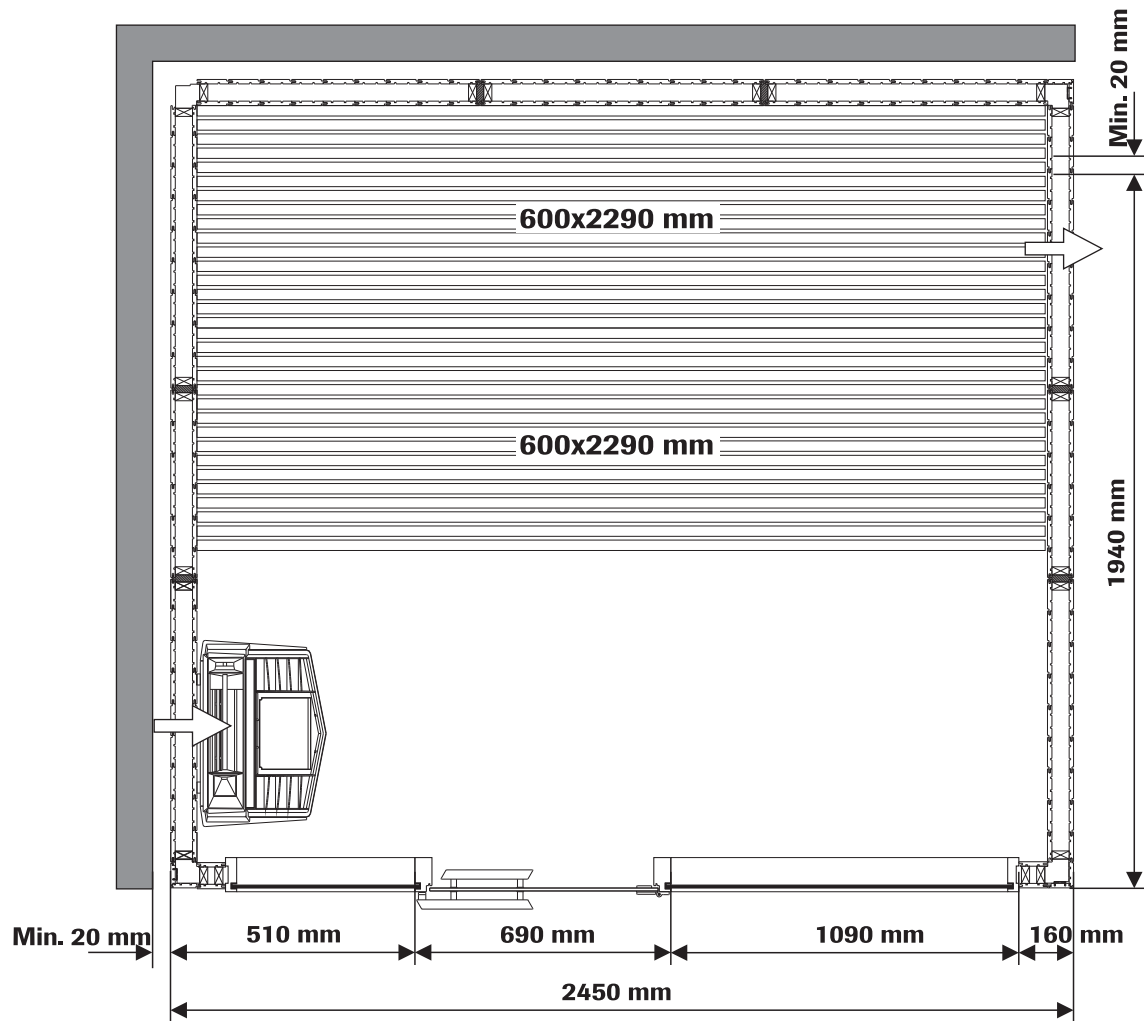

Art.nr 2900 4376

TYLÖ[®]
for the senses

A1

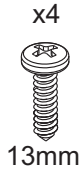
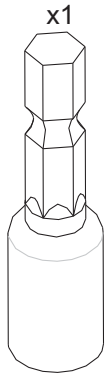

13mm

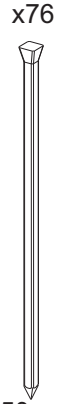

50mm

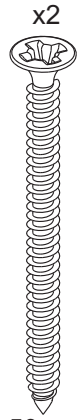

50mm

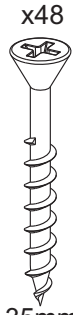

35mm

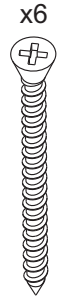

32mm

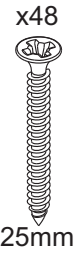

25mm



Lim
Glue



Ø 2



Ø 3.5

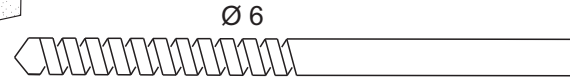

Ø 6

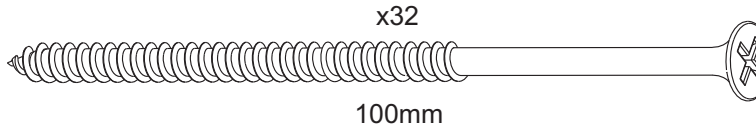

x32

100mm

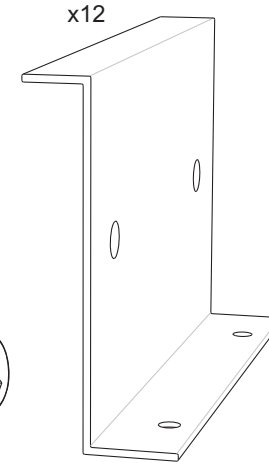

x12

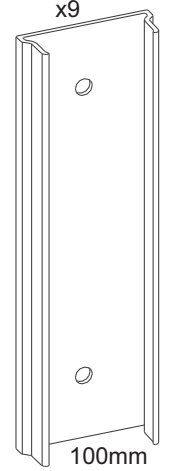

x9

100mm

A2



6.5mm



16mm

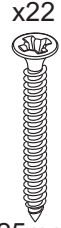

25mm

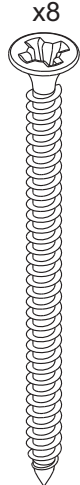

60mm

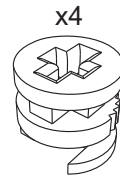

x4



x8

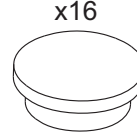

x16

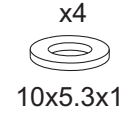

10x5.3x1

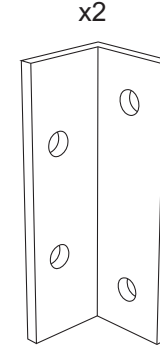

x2

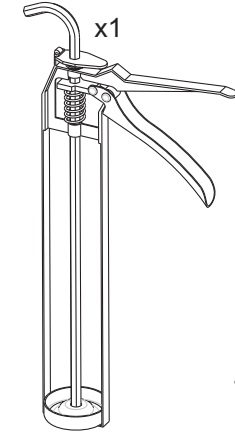

x1



x1



Ø 4.5

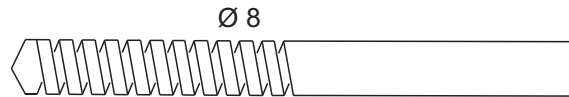

Ø 8

B

x10m

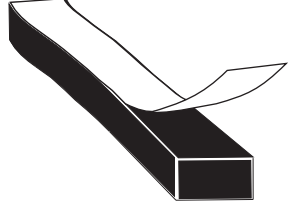

12x8mm

x11m

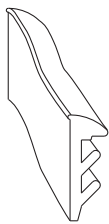

14x5mm

x8

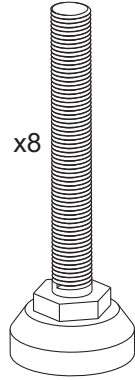
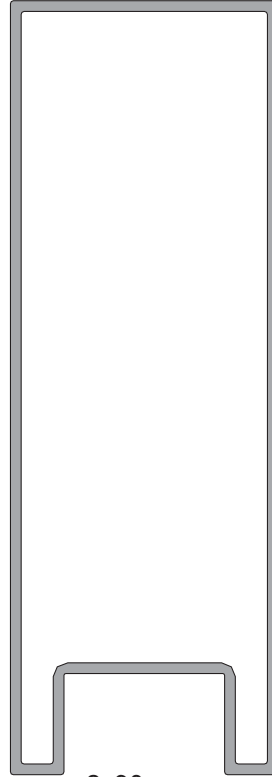
**P1**

2x90mm
1x1023mm
1x1299mm
2x2066mm

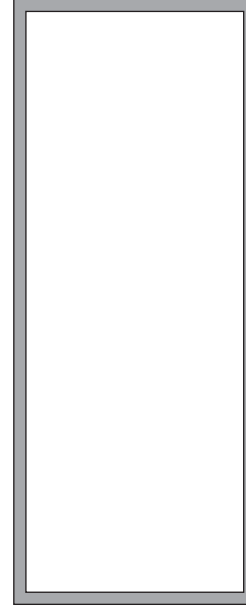
P15

1x150mm

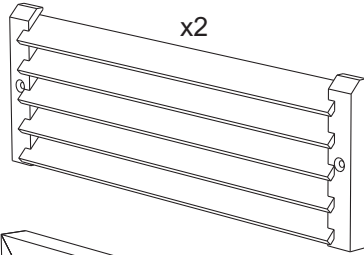

x2

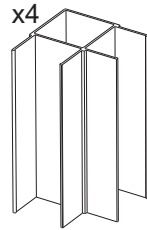

x4

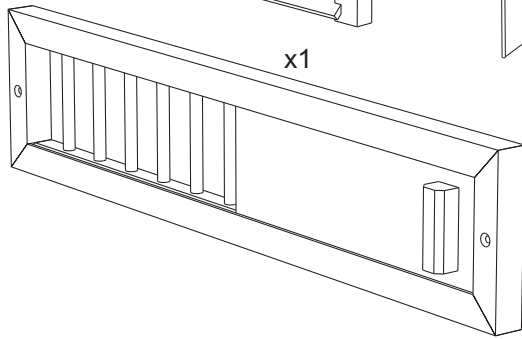

x1

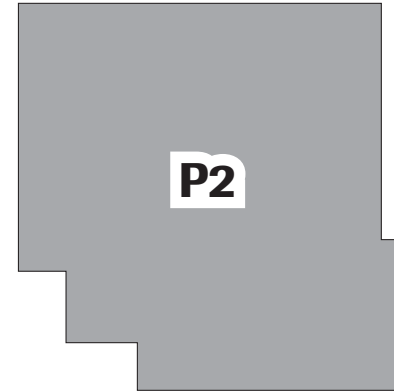
P2

4x1944mm

P3

4x189mm
4x1010mm
6x1970mm

P4

3x1970mm

P5

3x1970mm

P6

4x1750mm

P7

1x900mm
1x2000mm
1x2200mm

P8

3x2000mm
2x2100mm

P9

3x1970mm

P10

1x1217mm

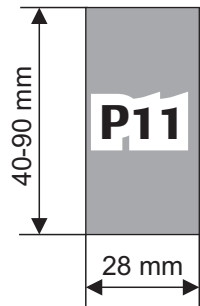

40-90 mm

P11

28 mm

18x90mm

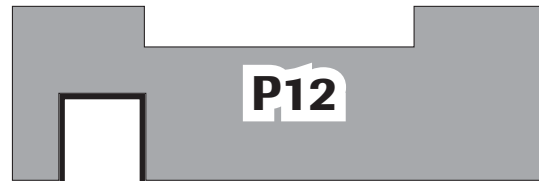
P12

1x482mm
1x908mm
2x1875mm

P13

2x30mm
1x482mm
1x908mm

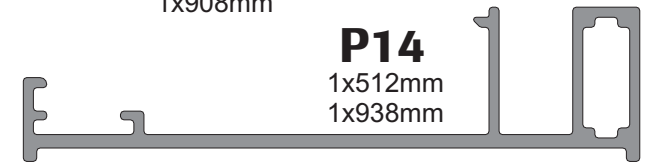
P14

1x512mm
1x938mm

C

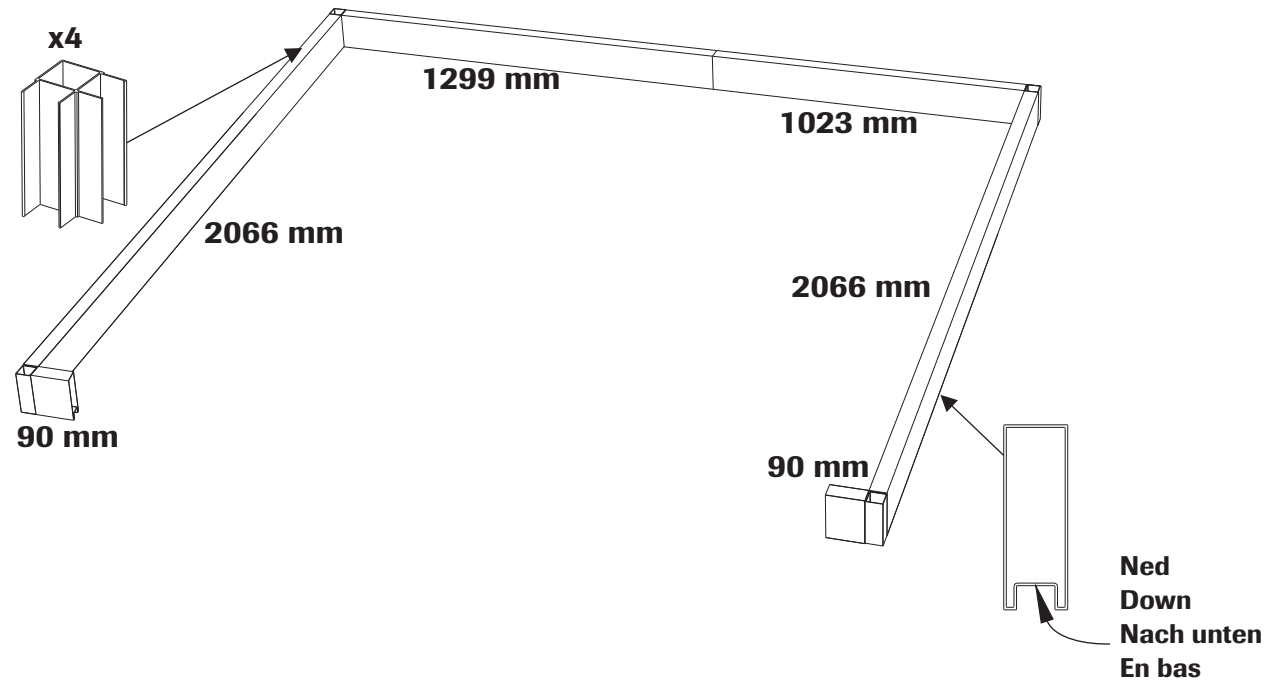
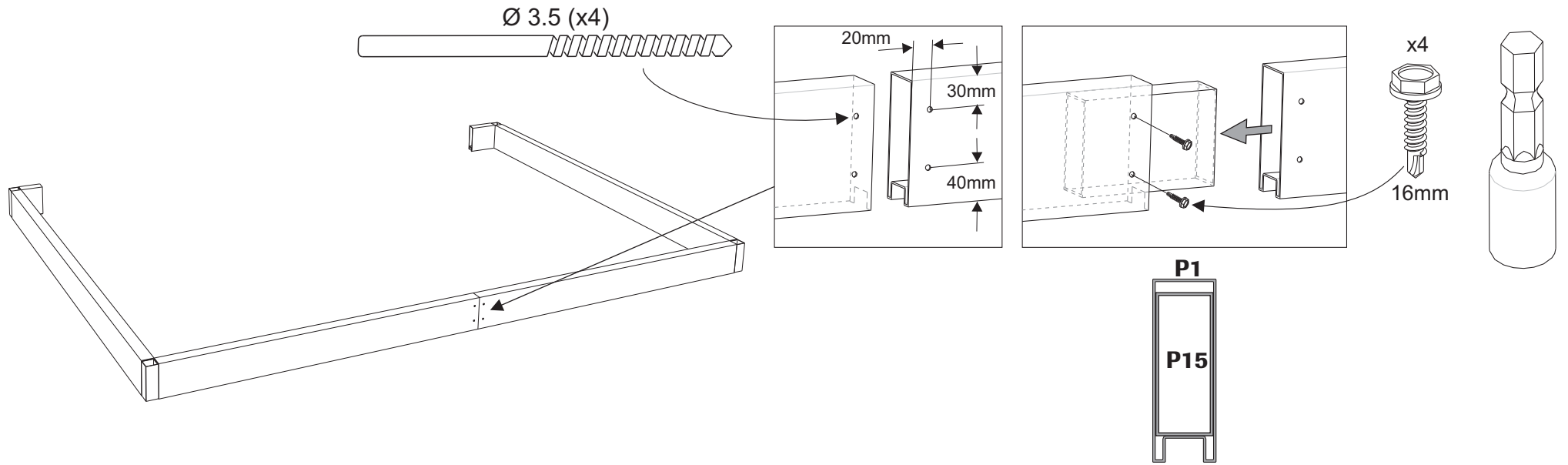

D

Monteringsordning - väggar
 Assembly order - walls

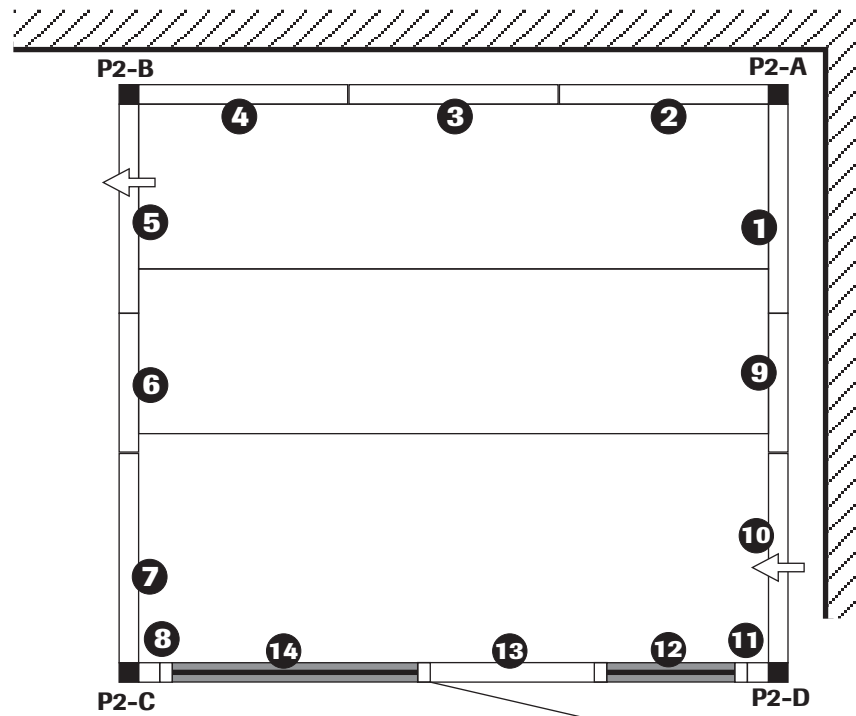
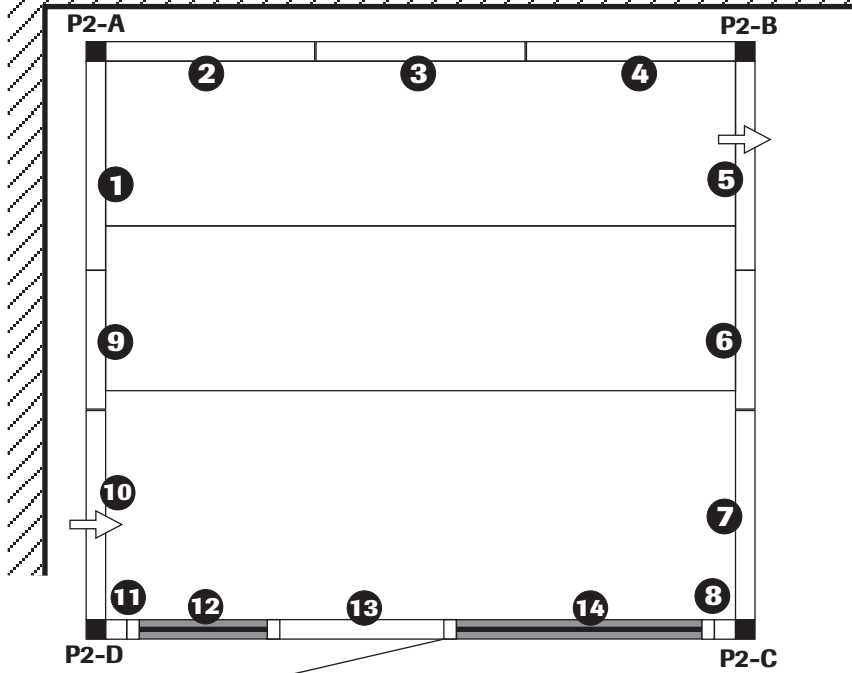

Väggyttermått
 Wall outer dimensions

| | |
|----------------------|--------|
| 1 2 3 4 5 7 10 | 762 mm |
| 6 9 | 506 mm |
| 8 11 | 77 mm |
| 12 (Glas/glass) | 512 mm |
| 14 (Glas/glass) | 938 mm |
| 13 (Dörr/door) | 690 mm |

E

Placering av skarvprofil.
Montering - se monteringsanvisning av rummet.

Location of the joint profile
Assembly - see installation instructions of the room.

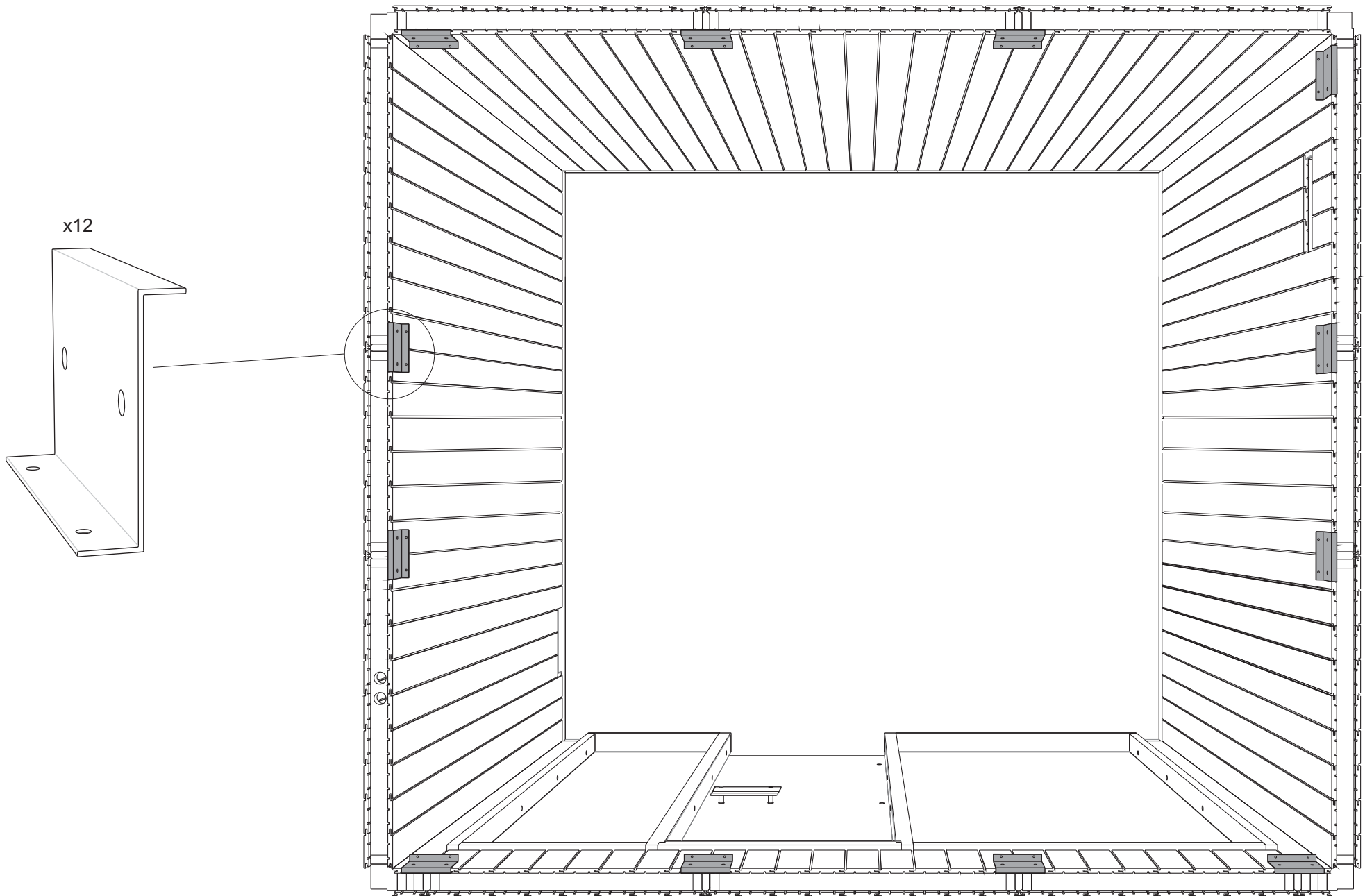

F Layouts 2422 PLUS GF

G = Glass

Standard

Layout 1

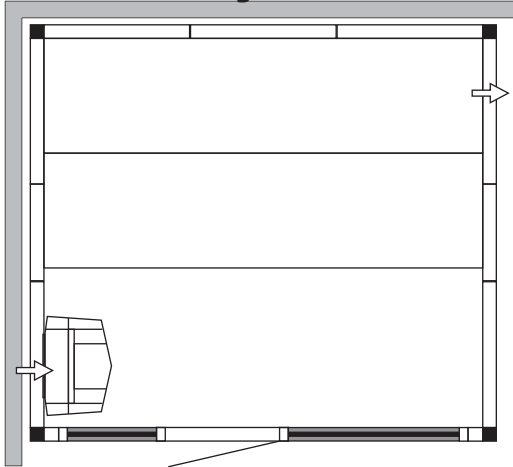

Layout 2

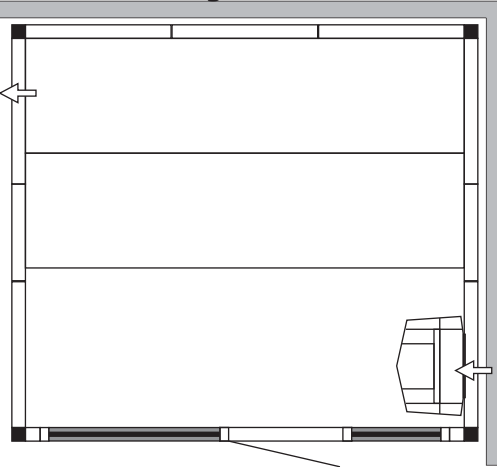

Standard with optional glass section

Layout 3

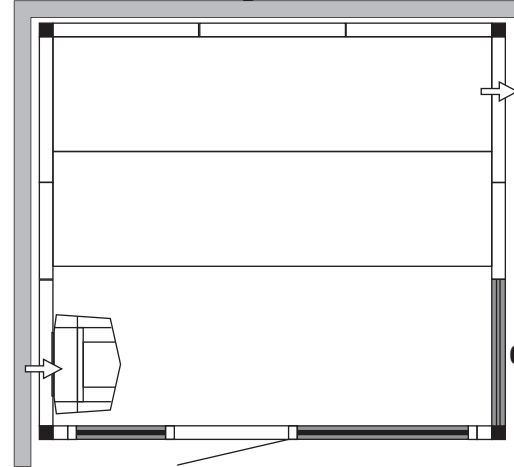

Layout 4

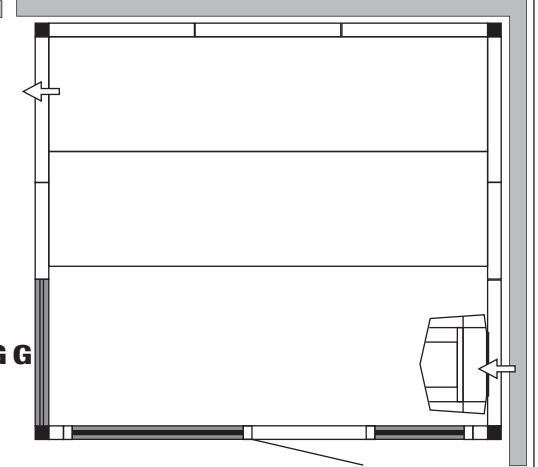

TYLÖ SAUNA E2719 PLUS GF

1202

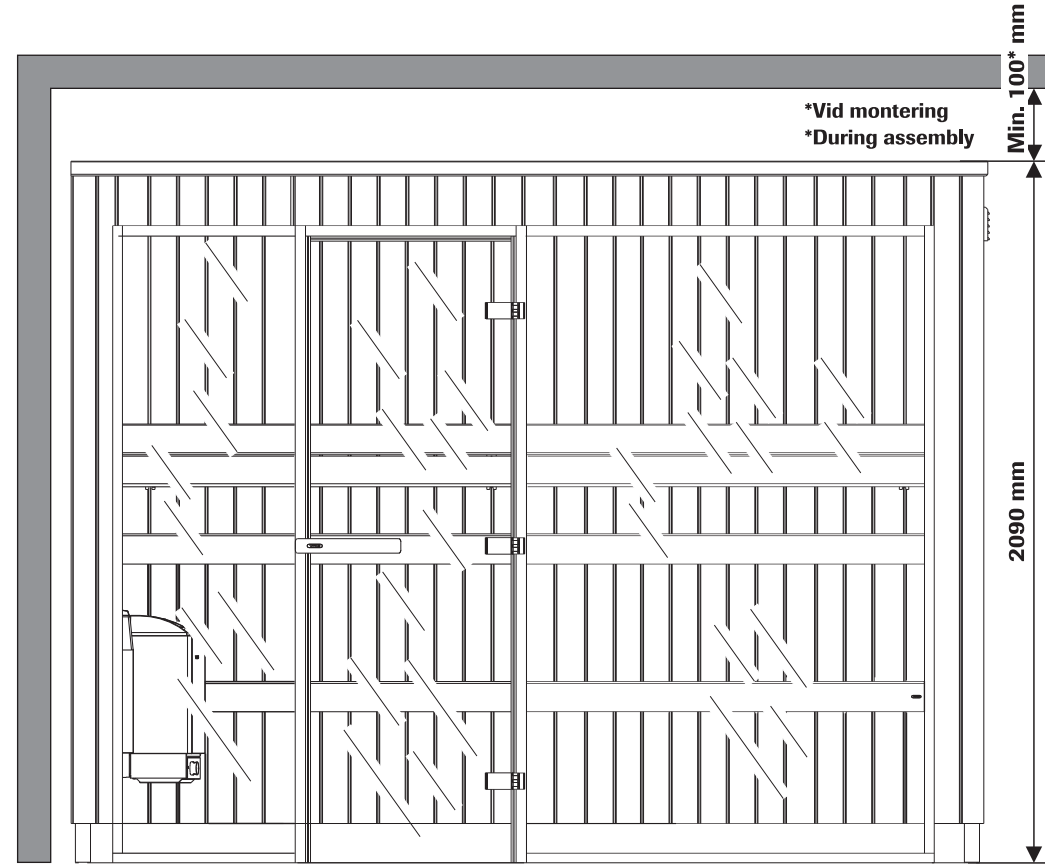
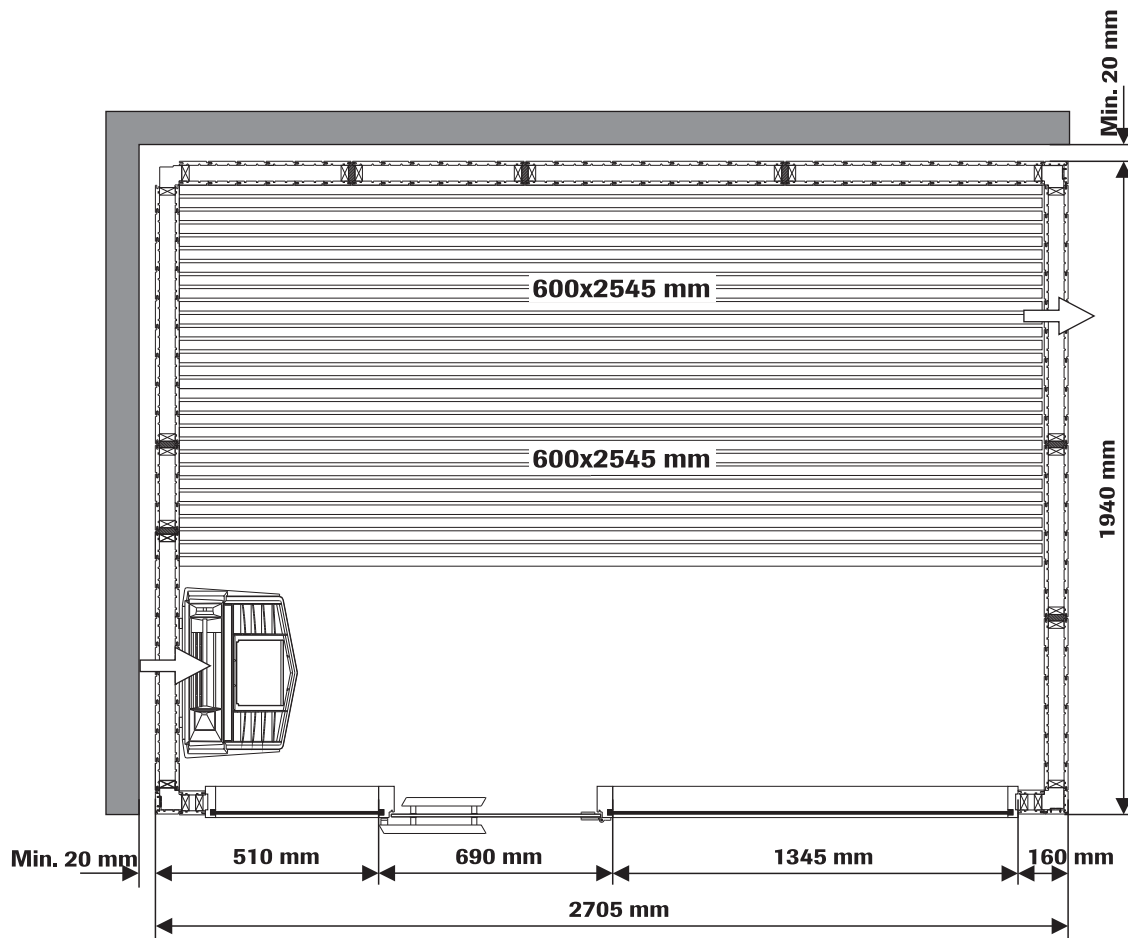

Art.nr 2900 4381

TYLÖ[®]
for the senses

A1

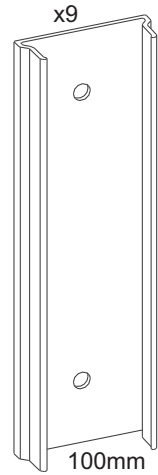
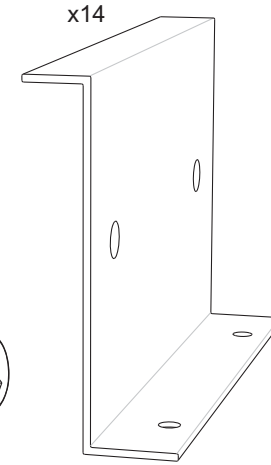
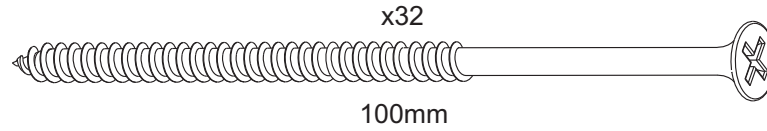
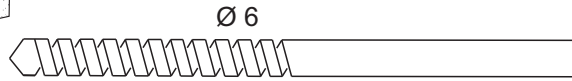
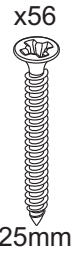
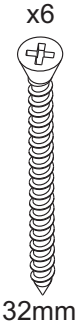
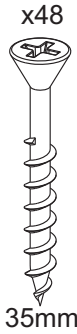
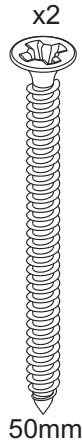
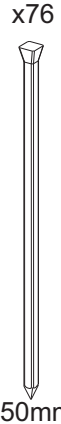
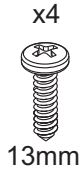
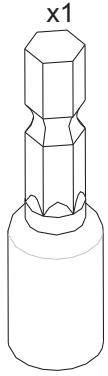

A2

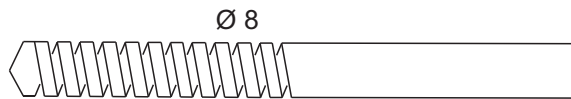
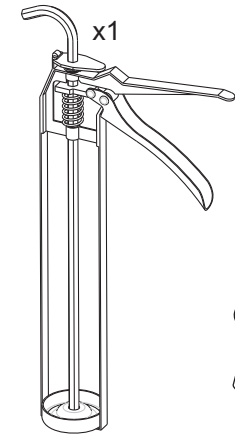
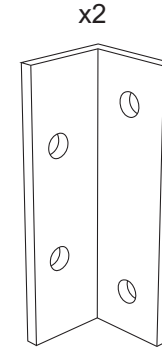
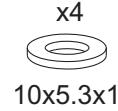
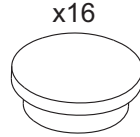
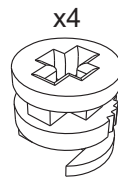
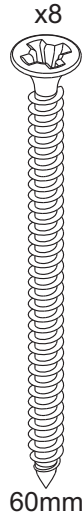
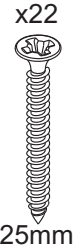

B

x9.5m

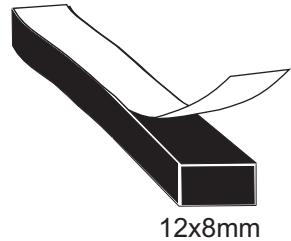

x12m

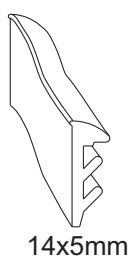

x8

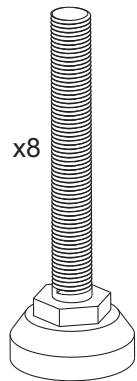
**P1**

2x90mm
1x1278mm
1x1299mm
2x1810mm

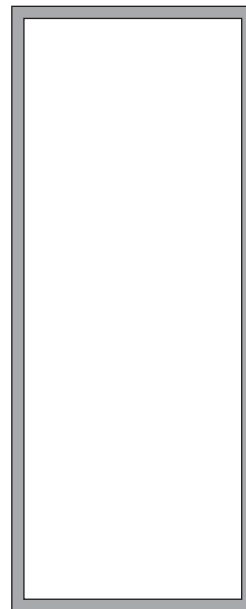
P15

1x150mm

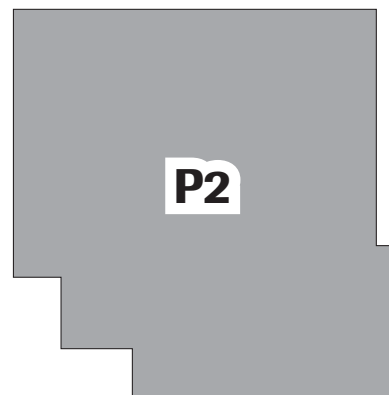
P2

4x1944mm

P6

4x1750mm

P7

1x900mm
2x2000mm

P8

5x2000mm

P9

3x1970mm

P10

1x1217mm

P3

5x189mm
2x1776mm
7x1970mm

P4

3x1970mm

P5

3x1970mm

P13

2x30mm
1x482mm
1x1164mm

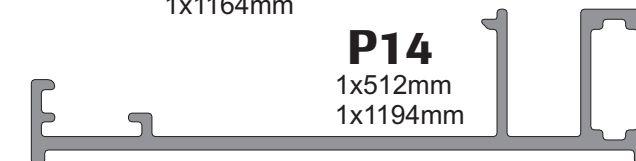
P14

1x512mm
1x1194mm

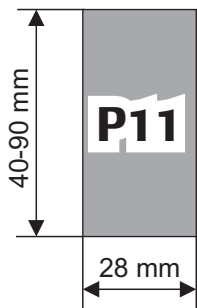
P11

40-90 mm

28 mm

18x90mm

P12

1x482mm
1x1164mm
2x1875mm

C

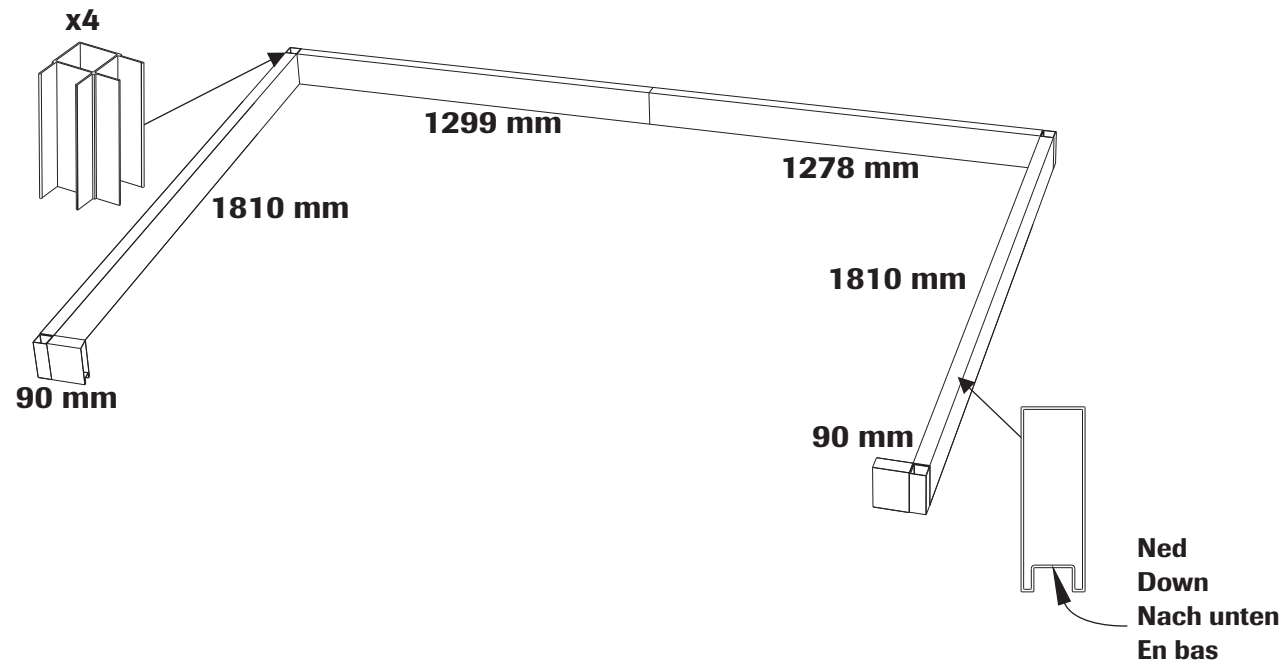
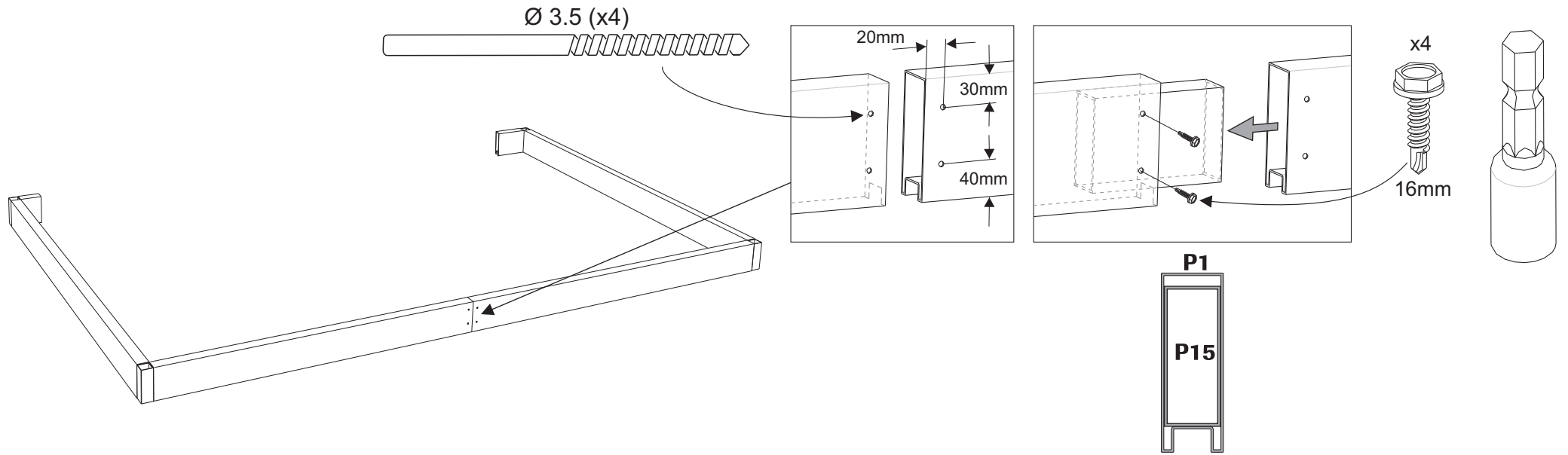

D

Monteringsordning - väggar
 Assembly order - walls

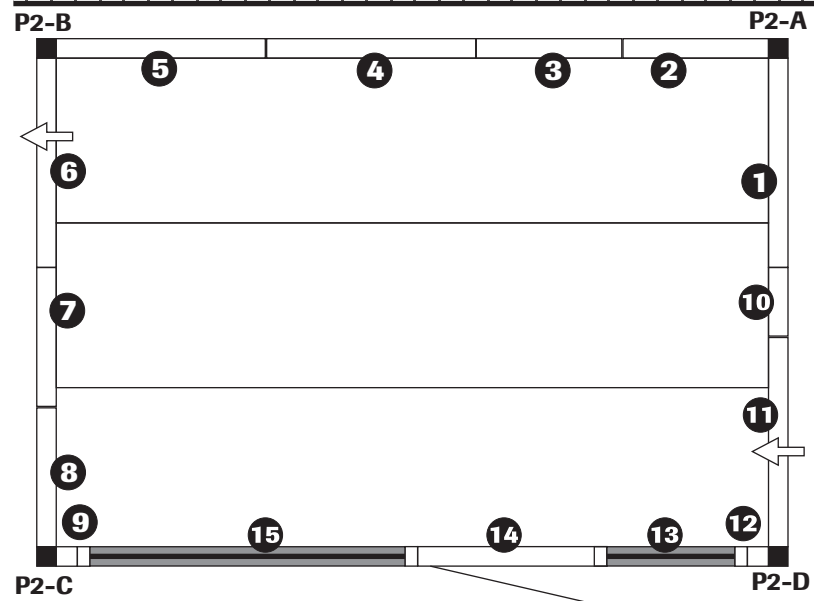
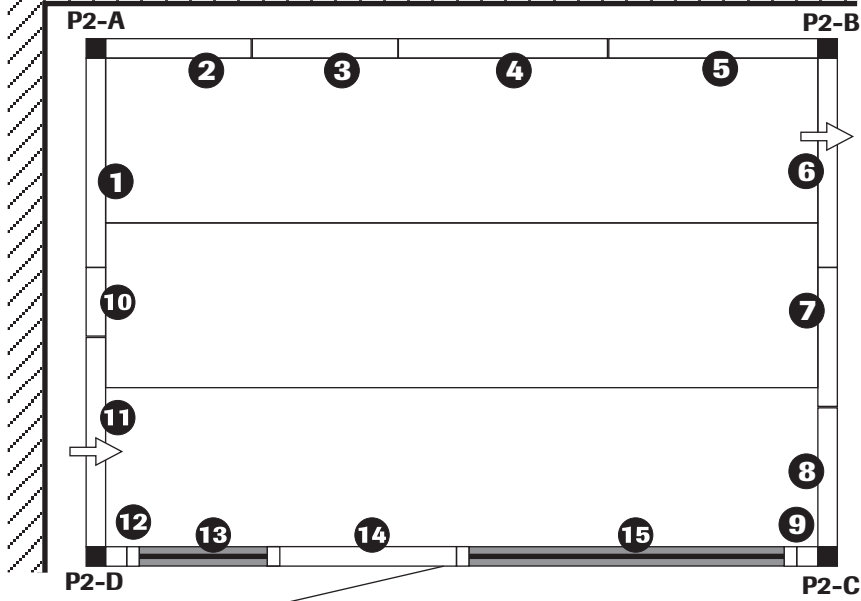

Väggyttermått
 Wall outer dimensions

| | |
|--------------------|---------|
| 1 4 5 6 11 | 762 mm |
| 2 3 7 8 | 506 mm |
| 10 | 250 mm |
| 9 12 | 77 mm |
| 13 (Glas/glass) | 512 mm |
| 15 (Glas/glass) | 1194 mm |
| 14 (Dörr/door) | 690 mm |

E

Placering av skarvprofil.
Montering - se monteringsanvisning av rummet.

Location of the joint profile
Assembly - see installation instructions of the room.

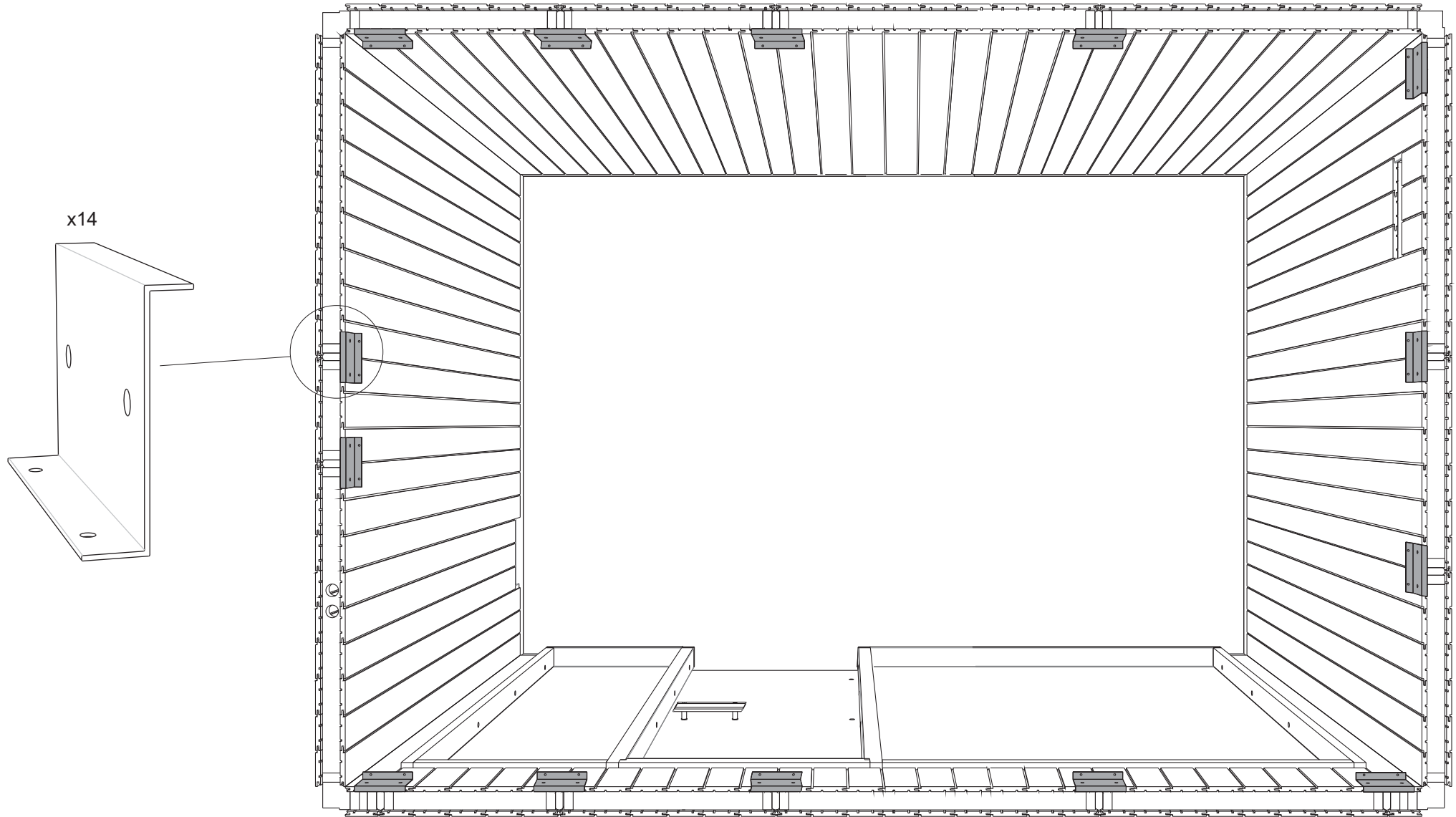

F Layouts 2719 PLUS GF

G = Glass

Standard

Layout 1

Layout 2

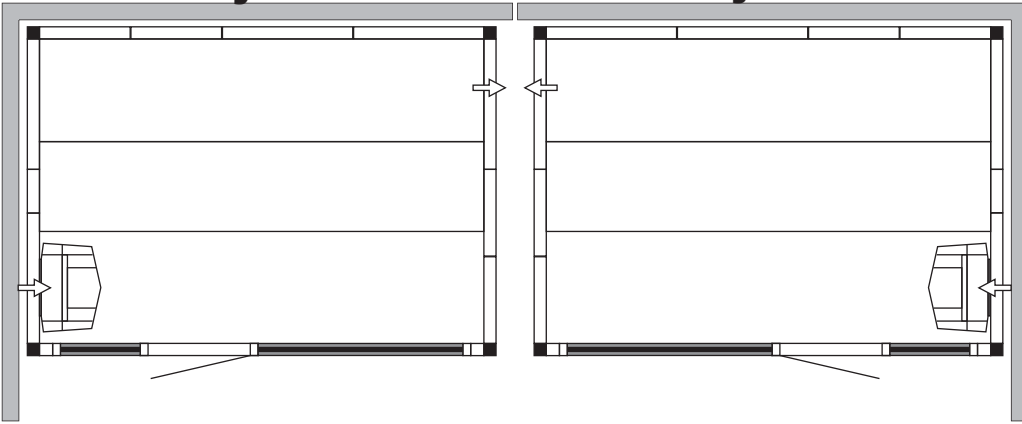

Standard with optional glass section

Layout 3

Layout 4

